

# P R B X

## POWERBOX Industrial Line T15W Series 15W 4:1 Single Output DC/DC Converter Manual

### Table of Contents

Output specification	P2
Input specification	P3
General specification	P3
Environmental specifications	P4
EMC characteristics	P4
Characteristic curves	P5
Input source impedance	P21
Output over current protection	P21
Output over voltage protection	P21
Short circuit protection	P21
Thermal consideration	P21
Remote on/off control	P22
Heat-sink	P22
Mechanical data	P23
Recommended pad layout	P23
Soldering considerations	P23
Packaging information	P23
Safety and installaion instruction	P24
MTBF and reliability	P24
Recommended external EMI filter	P25

### Introduction

The T15W single output series offer 15 watts of output power from a 2.00 X 1.00 X 0.40 inch package. The T15W single output series with 4:1 ultra wide input voltage of 9~36VDC, 18~75VDC. The T15W single output series features 1600VDC of isolation, short circuit and over voltage protection, as well as six sided shielding. All models are particularly suited to telecommunications, industrial, mobile telecom and test equipment applications.



### DC/DC Converter Features

Single output current to 4.5A
15 watts maximum output power
4:1 ultra wide input power range of 9~36VDC and 18~75VDC
Six-sided continuous shield
Case grounding
High efficiency up to 88%
Low profile 2.00 x 1.00 x 0.40 inch (50.8 x 25.4 x 10.2 mm)
Fixed switching frequency
RoHS Directive compliant
No minimum load
Input to output isolation 1600VDC, min
Operating case temperature range 105°C max
Input under-voltage protection
Output over-voltage protection
Over-current protection, auto-recovery
Output short circuit protection
Remote on/off

### Options

Heat-sink available for extended operation
Remote on/off logic configuration

POWERBOX Industrial Line  
T15W Series  
15W 4:1 Single Output  
DC/DC Converter  
Manual

Output Specifications

Parameters	Model	Min	Typ	Max	Unit
Output voltage ( $V_{in(nom)}$ ; full load; $T_a=25^\circ\text{C}$ )	□□S3P3W	3.267	3.3	3.333	VDC
	□□S05W	4.95	5	5.05	VDC
	□□S5P1W	5.05	5.1	5.15	VDC
	□□S12W	11.88	12	12.12	VDC
	□□S15W	14.85	15	15.15	VDC
<i>Output regulation</i>					
Line ( $V_{in(min)}$ to $V_{in(max)}$ at full load)	All	-0.2		+0.2	%
Load (0% to 100% of full load)	All	-0.5		+0.5	%
<i>Output ripple and noise</i>					
Peak to peak (20MHz bandwidth) (Measured with a 0.1 $\mu\text{F}$ /50V MLCC)	□□S3P3W		50	75	mVp-p
	□□S05W		50	75	mVp-p
	□□S5P1W		50	75	mVp-p
	□□S12W		75	100	mVp-p
	□□S15W		75	100	mVp-p
Temperature coefficient	All	-0.02		+0.02	%/ $^\circ\text{C}$
Output voltage overshoot ( $V_{in(min)}$ to $V_{in(max)}$ full load; $T_a=25^\circ\text{C}$ )	All		0	5	% of $V_{out}$
<i>Dynamic load response (<math>V_{in(nom)}</math>; <math>T_a=25^\circ\text{C}</math>)</i>					
Load step change from 75% to 100% or 100 to 75% of full load					
Peak deviation	All		200		mV
Setting time ( $V_o < 10\%$ peak deviation)	All		250		$\mu\text{s}$
Output current	□□S3P3W	0		4500	mA
	□□S05W	0		3000	mA
	□□S5P1W	0		3000	mA
	□□S12W	0		1250	mA
	□□S15W	0		1000	mA
Output over voltage protection (zener diode clamp)	□□S3P3W		3.9		VDC
	□□S05W		6.2		VDC
	□□S5P1W		6.2		VDC
	□□S12W		15		VDC
	□□S15W		18		VDC
Output over current protection	All		150		% of FL
Output short circuit protection	All	Hiccups, automatics recovery			

POWERBOX Industrial Line  
T15W Series  
15W 4:1 Single Output  
DC/DC Converter  
Manual

Input Specifications

Parameters	Model	Min	Typ	Max	Unit
Operating input voltage	24S□□W	9	24	36	VDC
	48S□□W	18	48	75	VDC
<i>Input voltage</i>					
Continuous	24S□□W			36	VDC
	48S□□W			75	VDC
Transient (100mS maximum)	24S□□W			50	VDC
	48S□□W			100	VDC
Input voltage variation (complies with ETS300 132 part 4.4)	All			5	V/ms
<i>Input current</i>					
(maximum value at $V_{in}=V_{in(nom)}$ ), full load	24S3P3W			755	mA
	24S05W			753	mA
	24S5P1W			768	mA
	24S12W			753	mA
	24S15W			753	mA
	48S3P3W			377	mA
	48S05W			372	mA
	48S5P1W			379	mA
	48S12W			377	mA
	48S15W			377	mA
<i>Input standby current</i>					
(typical value at $V_{in}=V_{in(nom)}$ ), no load	24S3P3W		50		mA
	24S05W		65		mA
	24S5P1W		65		mA
	24S12W		22		mA
	24S15W		22		mA
	48S3P3W		35		mA
	48S05W		35		mA
	48S5P1W		35		mA
	48S12W		15		mA
	48S15W		15		mA
Under voltage lockout turn-on threshold	24S□□W		9		VDC
	48S□□W		18		VDC
Under voltage lockout turn-off threshold	24S□□W		7.5		VDC
	48S□□W		15		VDC
Input reflected ripple current (5 to 20MHz, 12 $\mu$ H source impedance)	All		20		mA <sub>p-p</sub>
<i>Start up time (<math>V_{in} = V_{in(nom)}</math> and constant resistive load)</i>					
Power up	All		20	40	mS
Remote on/off	All		20	40	mS
<i>Remote on/off (the CTRL pin voltage is referenced to -INPUT)</i>					
CTRL pin high voltage (remote on)	All	3		12	VDC
CTRL pin low voltage (remote off)	All	0		1.2	VDC
Remote off state input current	All		2.5		mA
Input current of remote control pin	All	-0.5		0.5	mA

POWERBOX Industrial Line  
T15W Series  
15W 4:1 Single Output  
DC/DC Converter  
Manual

General Specifications

Parameters	Model	Min	Typ	Max	Unit
<i>Efficiency</i> ( $V_{in} = V_{in(nom)}$ ), Full Load, $T_A=25^{\circ}C$ )	24S3P3W		86		%
	24S05W		87		%
	24S5P1W		87		%
	24S12W		87		%
	24S15W		87		%
	48S3P3W		86		%
	48S05W		88		%
	48S5P1W		88		%
	48S12W		87		%
	48S15W		87		%
<i>Isolation voltage (1 minute)</i>					
Input to output	All	1600			VDC
Input to case, output to case	All	1600			VDC
Isolation resistance	All	1			GΩ
Isolation capacitance	All			1500	pF
Switching frequency	All	360	400	440	kHz
Weight	All		27		g
MTBF MIL-HDBK-217F	All		$2.430 \times 10^6$		hours
Case material	All	Nickel-coated copper			
Base material	All	FR4 PCB			
Potting material	All	Epoxy (UL94 V-0)			
Dimensions	All	50.8 x 25.4 x 10.2 mm (2.00 x 1.00 x 0.40 inch)			

Environmental Specifications

Parameters	Model	Min	Typ	Max	Unit
Operating ambient temperature (without derating)*	All	-40		76	°C
Operating ambient temperature (with derating)*	All	76		105	°C
Operating case temperature	All			105	°C
Storage temperature	All	-55		125	°C
<i>Thermal impedance</i>					
Natural convection	All		12		°C/W
Natural convection with heat-sink	All		10		°C/W
Thermal shock	All	MIL-STD-810F			
Vibration	All	MIL-STD-810F			
Relative humidity	All	5% to 95% RH			

\*Test condition with vertical direction by natural convection (20LFM)

EMC Characteristics

Parameters	Standard	Condition		Level
EMI	EN55022			Class A
ESD	EN61000-4-2	Air	±8kV	Perf. Criteria A
		Contact	±6kV	
Radiated Immunity	EN61000-4-3		10V/m	Perf. Criteria A
Fast transient*	EN61000-4-4		±2kV	Perf. Criteria A
Surge*	EN61000-4-5		±1kV	Perf. Criteria A
Conducted immunity	EN61000-4-6		10V r.m.s	Perf. Criteria A
Power frequency magnetic field	EN61000-4-8	100A/m continuous;		Perf. Criteria A
		1000A/m 1 second		

\*An external input filter capacitor is required if the module has to meet EN61000-4-4, EN61000-4-5.  
The filter capacitor Powerbox suggest: Nippon chemi-con KY series, 220µF/100V, ESR 48mΩ.

POWERBOX Industrial Line  
 T15W Series  
 15W 4:1 Single Output  
 DC/DC Converter  
 Manual

All test conditions are at 25°C. The figures are identical for PMD15-24S3P3W

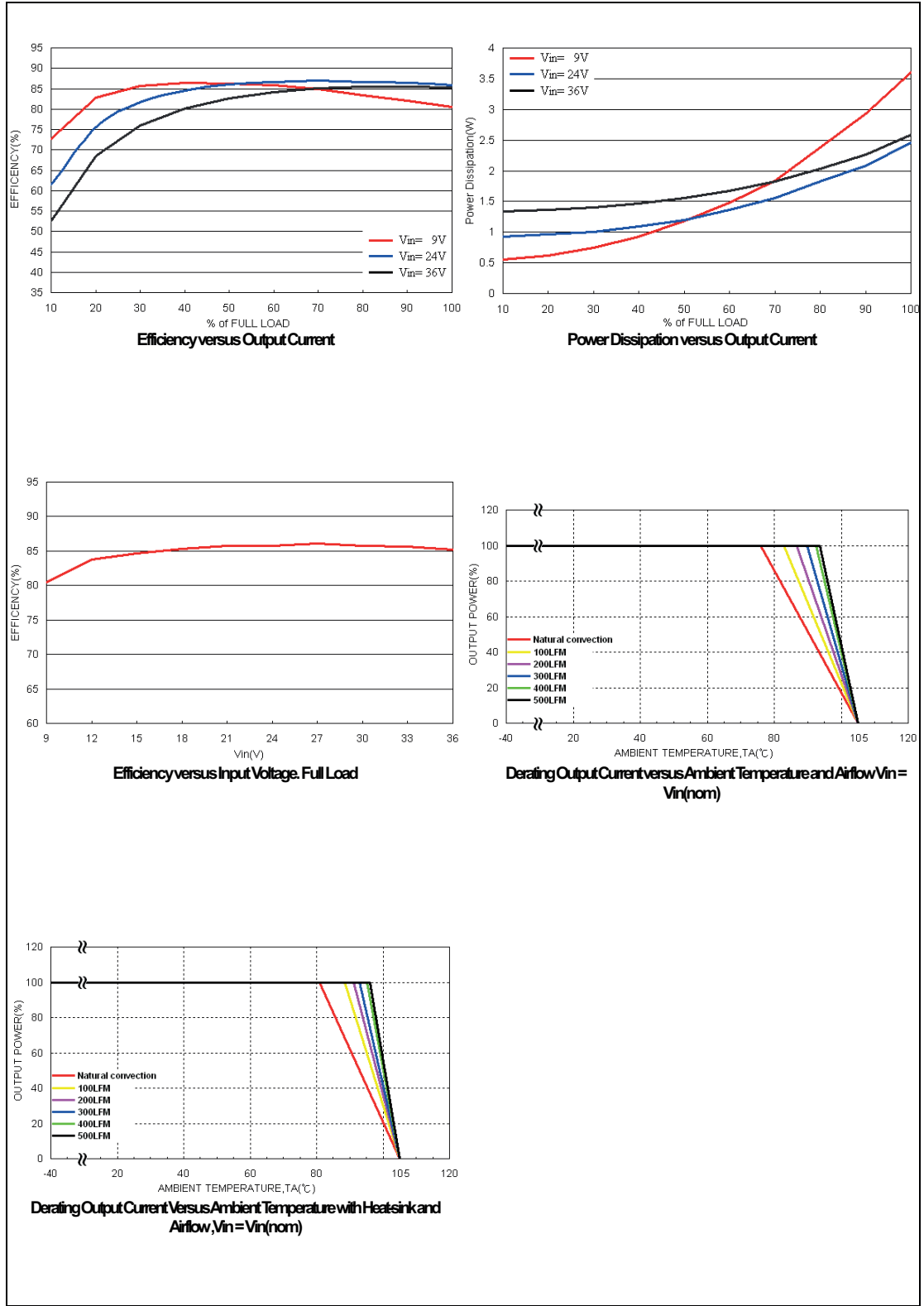

POWERBOX Industrial Line  
 T15W Series  
 15W 4:1 Single Output  
 DC/DC Converter  
 Manual

All test conditions are at 25°C. The figures are identical for PMD15-24S3P3W

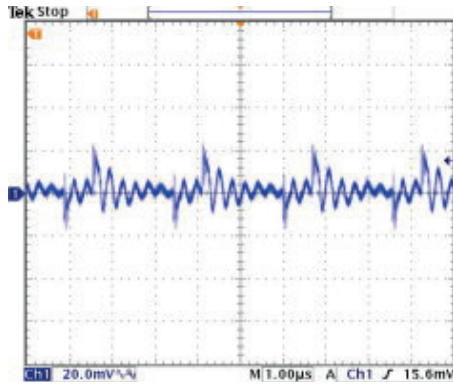

Typical Output Ripple and Noise.  
 $V_{in} = V_{in(nom)}$ , Full Load

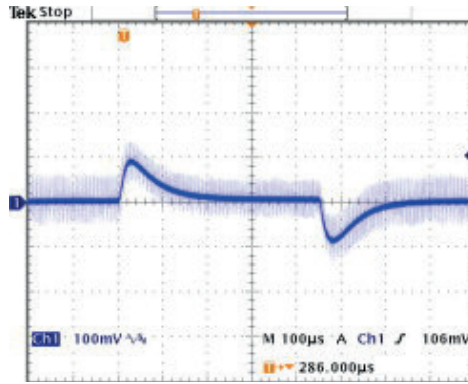

Transient Response to Dynamic Load Change from  
 100% to 75% to 100% of Full Load,  $V_{in} = V_{in(nom)}$

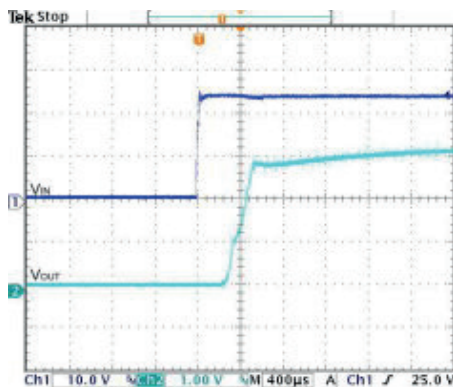

Typical Input Start-Up and Output Rise Characteristic  
 $V_{in} = V_{in(nom)}$ , Full Load

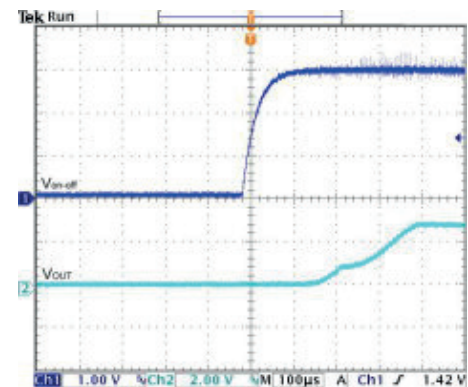

Using ON/OFF Voltage Start-Up and  $V_o$  Rise Characteristic  
 $V_{in} = V_{in(nom)}$ , Full Load

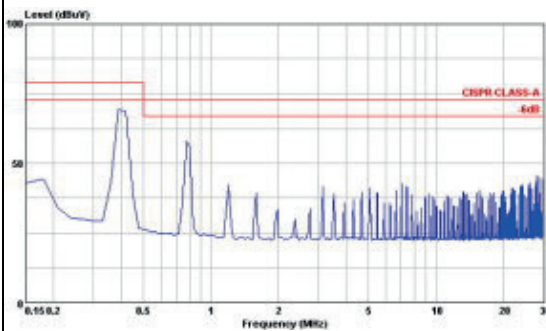

Conduction Emission of EN55022 Class A  
 $V_{in} = V_{in(nom)}$ , Full Load

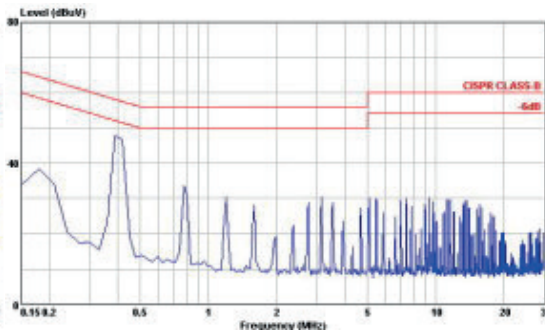

Conduction Emission of EN55022 Class B  
 $V_{in} = V_{in(nom)}$ , Full Load

POWERBOX Industrial Line  
 T15W Series  
 15W 4:1 Single Output  
 DC/DC Converter  
 Manual

All test conditions are at 25°C. The figures are identical for PMD15-24S05W

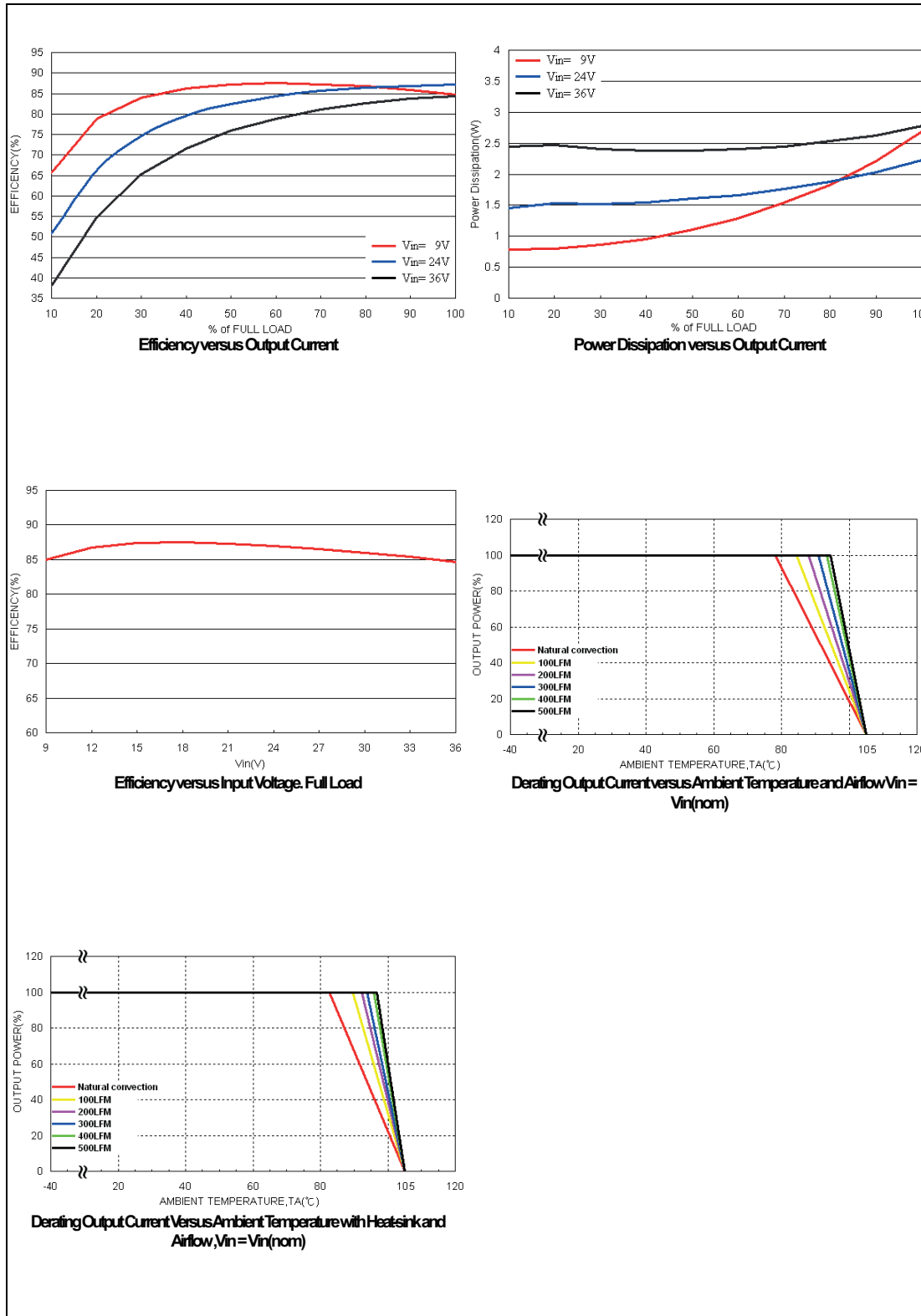

POWERBOX Industrial Line  
 T15W Series  
 15W 4:1 Single Output  
 DC/DC Converter  
 Manual

All test conditions are at 25°C. The figures are identical for PMD15-24S05W

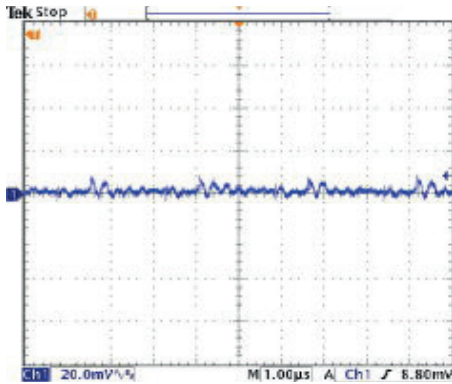

Typical Output Ripple and Noise.  
 $V_{in} = V_{in(nom)}$ , Full Load

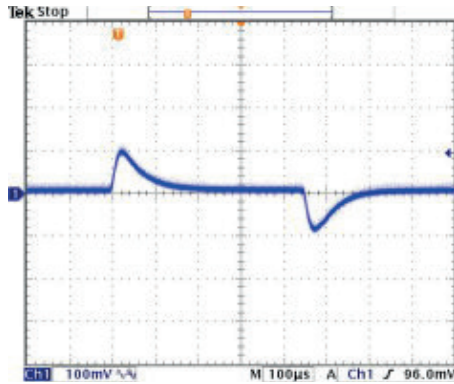

Transient Response to Dynamic Load Change from  
 100% to 75% to 100% of Full Load,  $V_{in} = V_{in(nom)}$

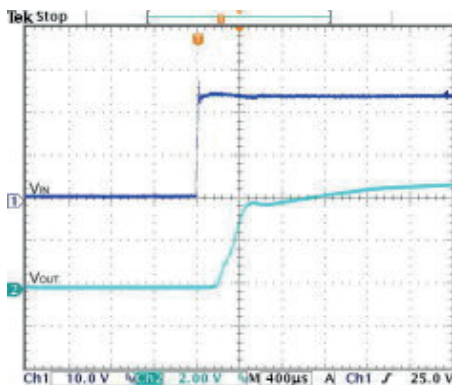

Typical Input Start-Up and Output Rise Characteristic  
 $V_{in} = V_{in(nom)}$ , Full Load

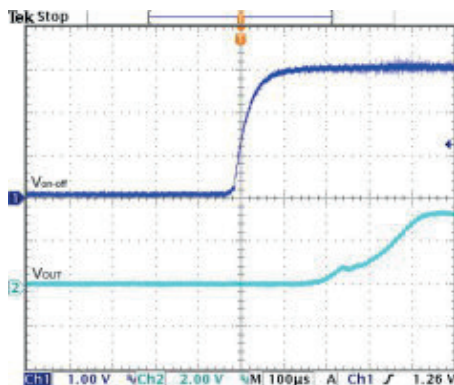

Using ON/OFF Voltage Start-Up and  $V_o$  Rise Characteristic  
 $V_{in} = V_{in(nom)}$ , Full Load

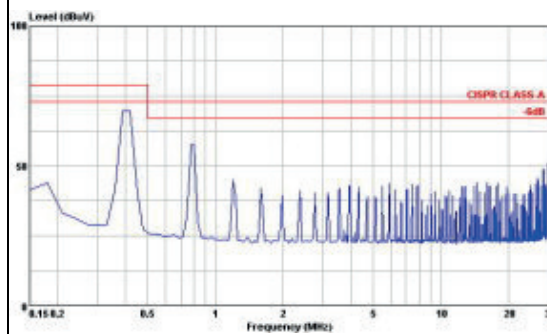

Conduction Emission of EN55022 Class A  
 $V_{in} = V_{in(nom)}$ , Full Load

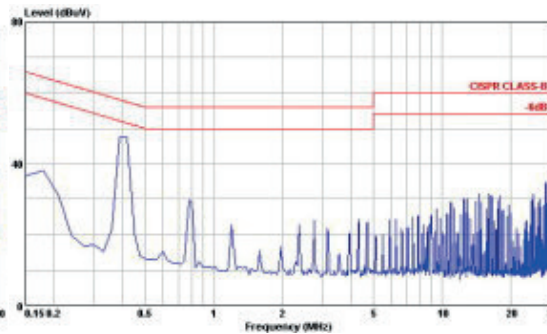

Conduction Emission of EN55022 Class B  
 $V_{in} = V_{in(nom)}$ , Full Load



POWERBOX Industrial Line  
 T15W Series  
 15W 4:1 Single Output  
 DC/DC Converter  
 Manual

All test conditions are at 25°C. The figures are identical for PMD15-24S12W

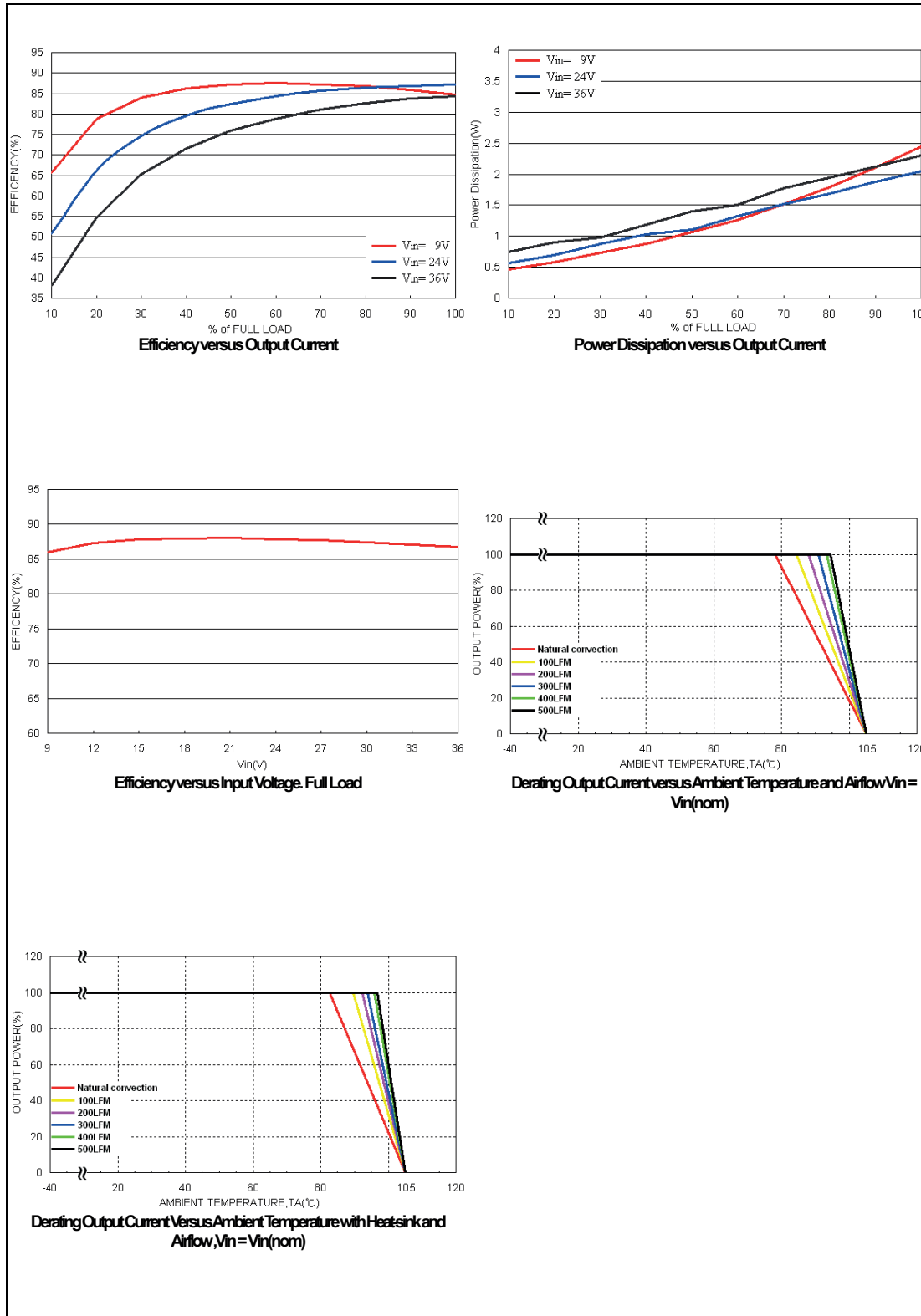

All test conditions are at 25°C. The figures are identical for PMD15-24S12W

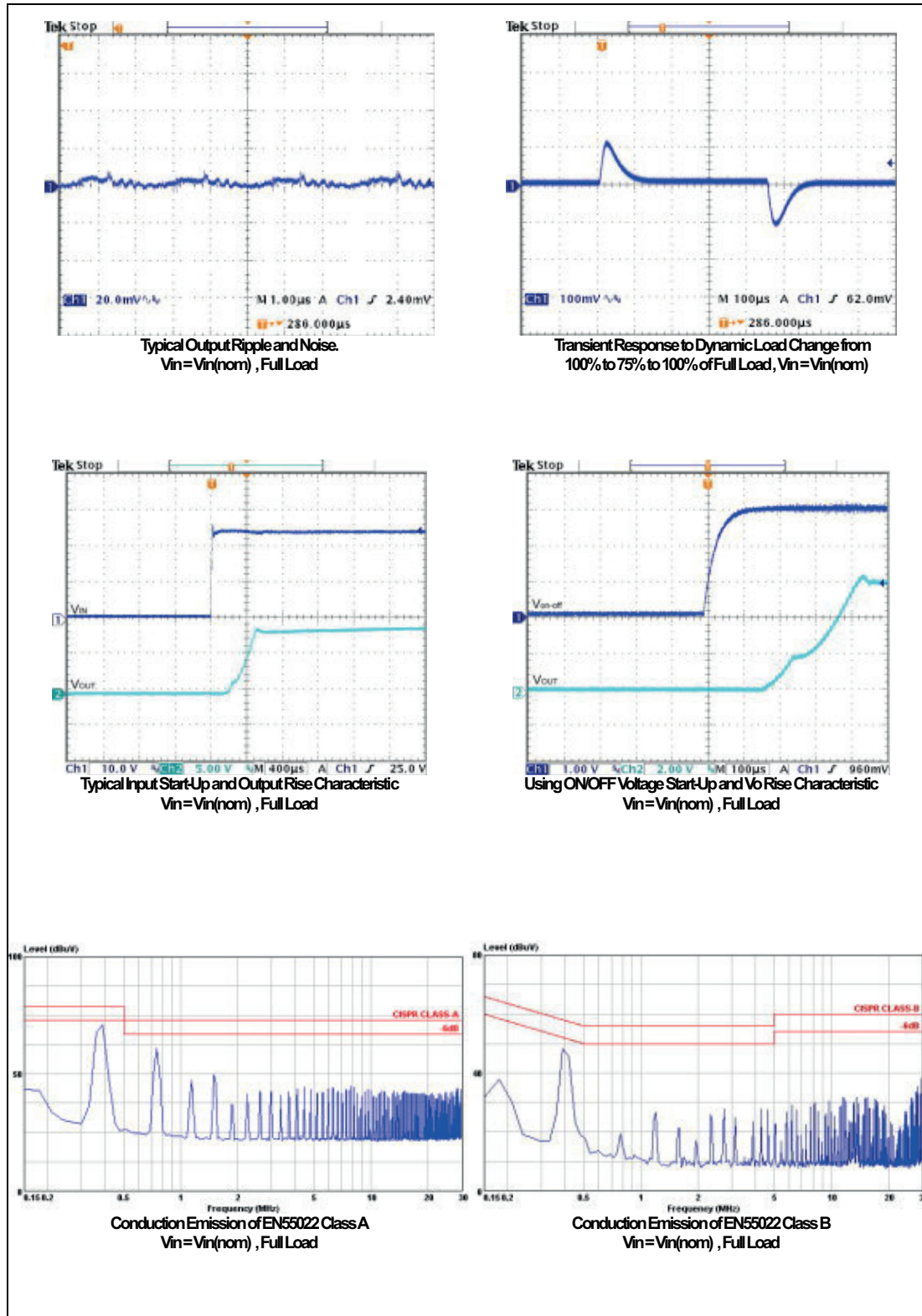

POWERBOX Industrial Line  
 T15W Series  
 15W 4:1 Single Output  
 DC/DC Converter  
 Manual

All test conditions are at 25°C. The figures are identical for PMD15-24S15W

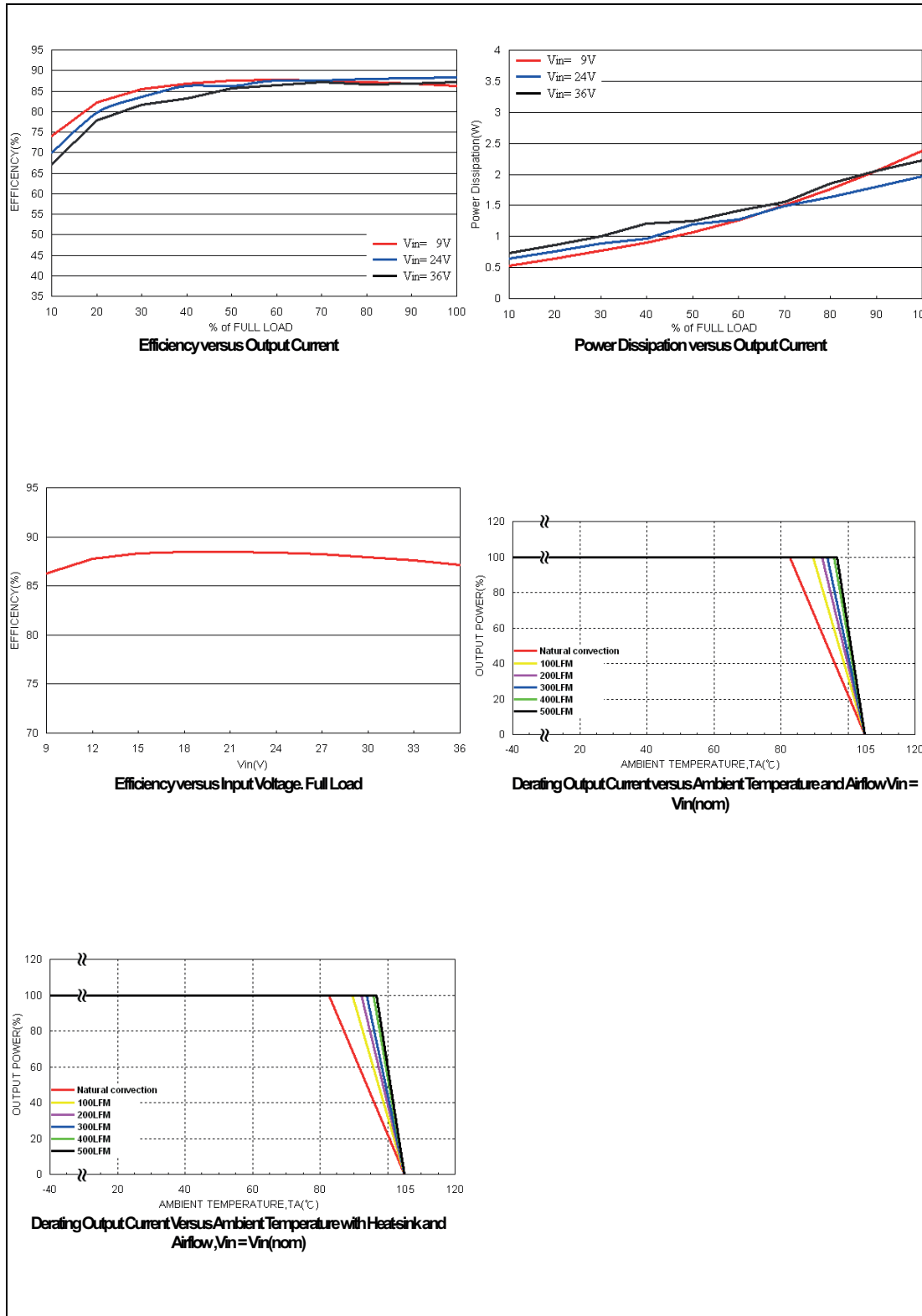

POWERBOX Industrial Line  
 T15W Series  
 15W 4:1 Single Output  
 DC/DC Converter  
 Manual

All test conditions are at 25°C. The figures are identical for PMD15-24S15W

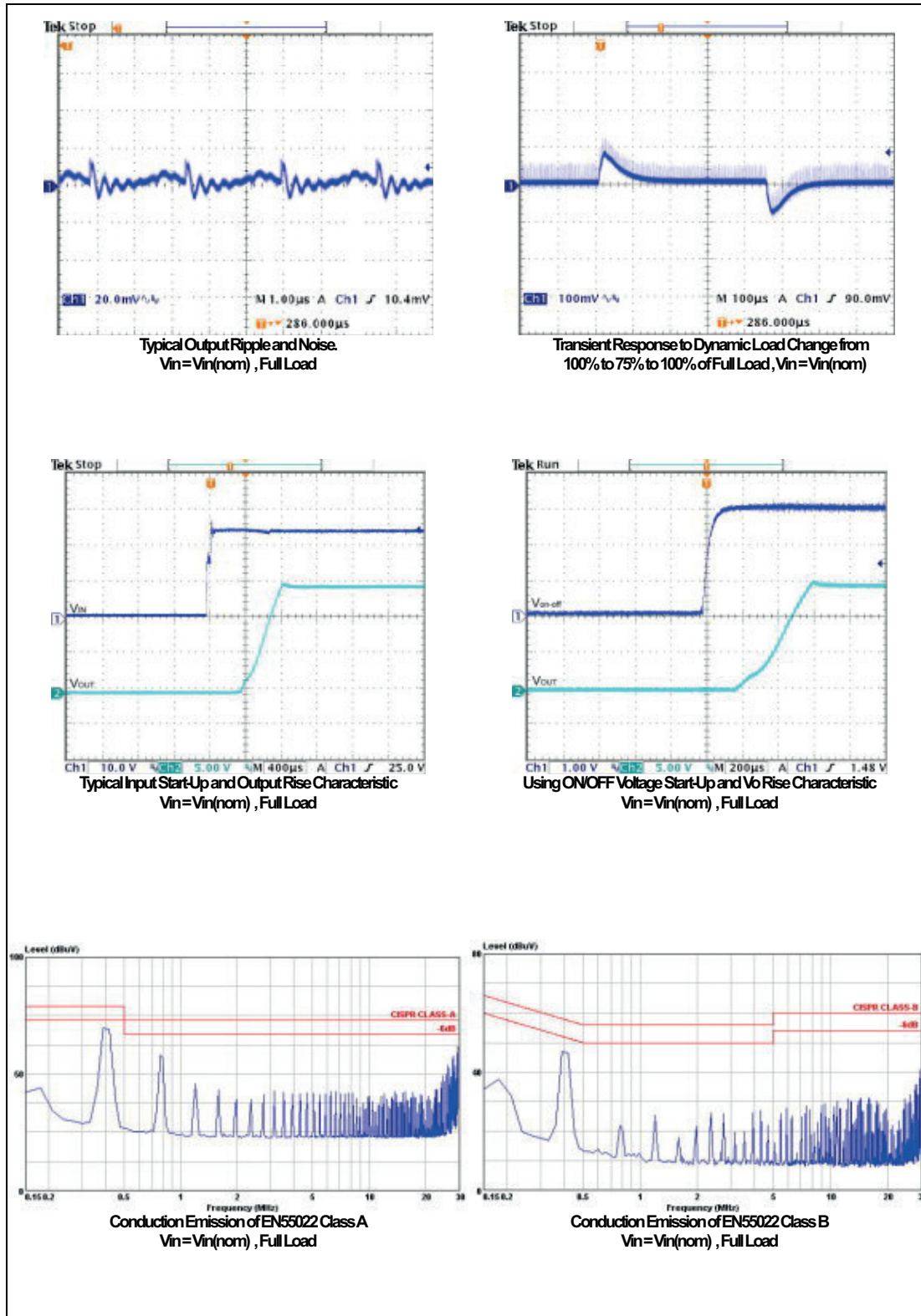

POWERBOX Industrial Line  
 T15W Series  
 15W 4:1 Single Output  
 DC/DC Converter  
 Manual

All test conditions are at 25°C. The figures are identical for PMD15-48S3P3W

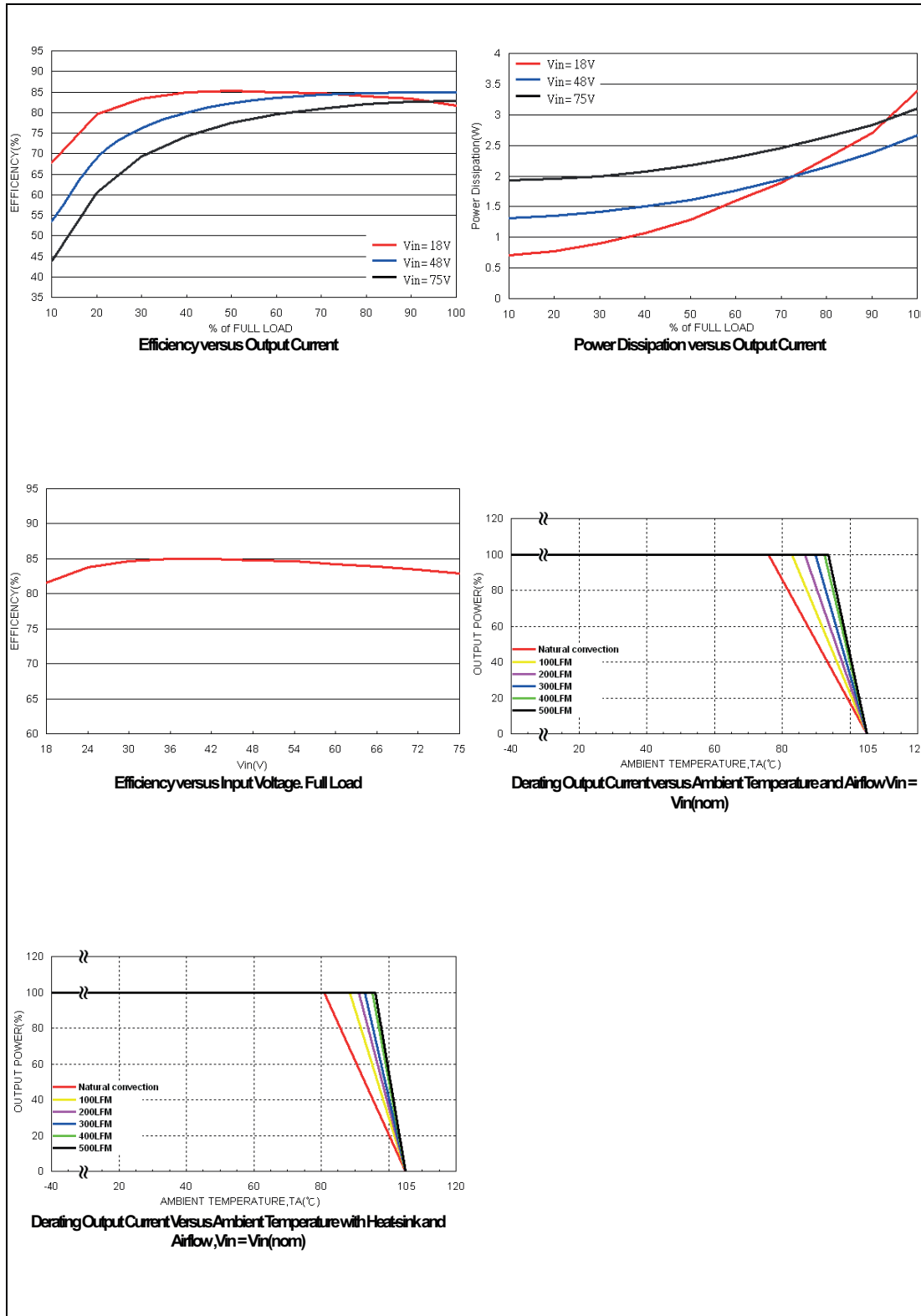

POWERBOX Industrial Line  
 T15W Series  
 15W 4:1 Single Output  
 DC/DC Converter  
 Manual

All test conditions are at 25°C. The figures are identical for PMD15-48S3P3W

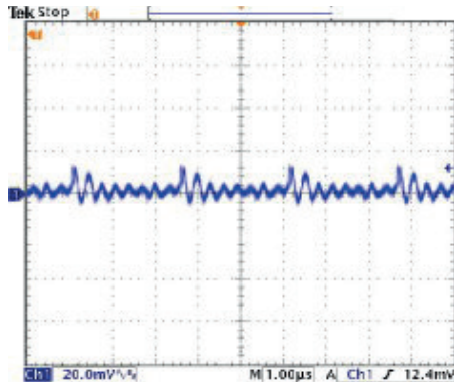

Typical Output Ripple and Noise.  
 $V_{in} = V_{in(nom)}$ , Full Load

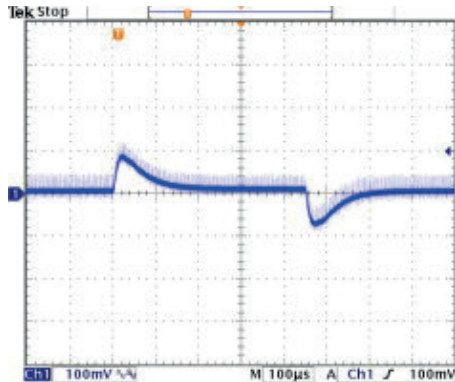

Transient Response to Dynamic Load Change from  
 100% to 75% to 100% of Full Load,  $V_{in} = V_{in(nom)}$

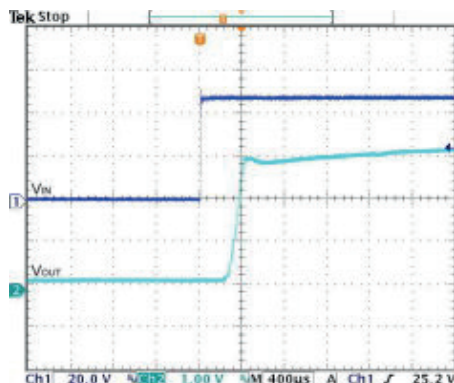

Typical Input Start-Up and Output Rise Characteristic  
 $V_{in} = V_{in(nom)}$ , Full Load

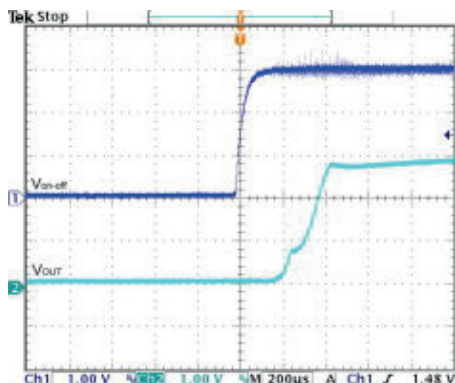

Using ON/OFF Voltage Start-Up and  $V_o$  Rise Characteristic  
 $V_{in} = V_{in(nom)}$ , Full Load

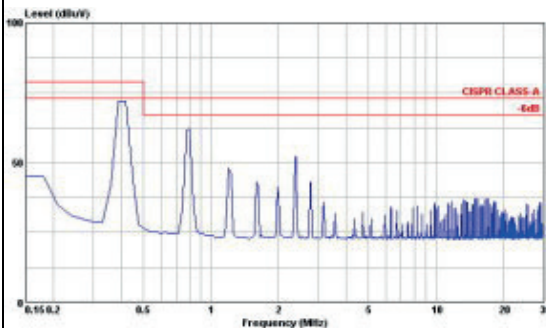

Conduction Emission of EN55022 Class A  
 $V_{in} = V_{in(nom)}$ , Full Load

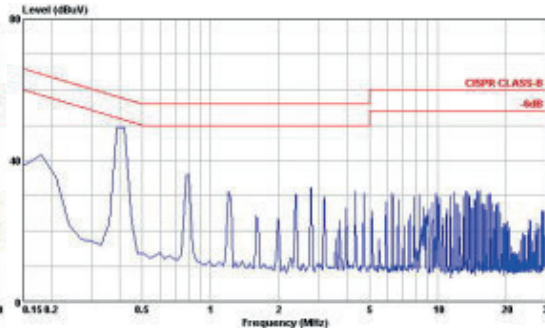

Conduction Emission of EN55022 Class B  
 $V_{in} = V_{in(nom)}$ , Full Load

POWERBOX Industrial Line  
 T15W Series  
 15W 4:1 Single Output  
 DC/DC Converter  
 Manual

All test conditions are at 25°C. The figures are identical for PMD15-48S05W

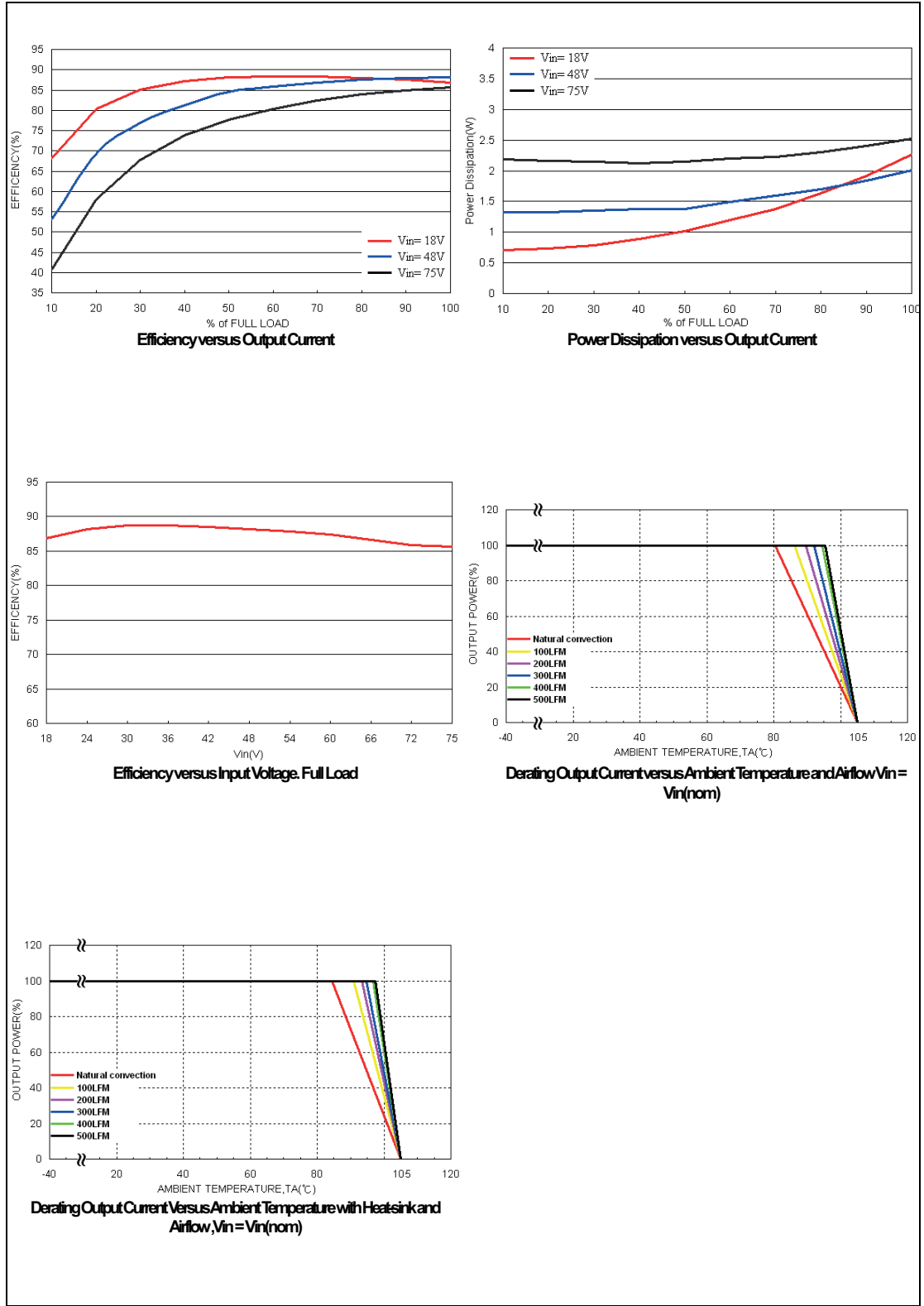

POWERBOX Industrial Line  
 T15W Series  
 15W 4:1 Single Output  
 DC/DC Converter  
 Manual

All test conditions are at 25°C. The figures are identical for PMD15-48S05W

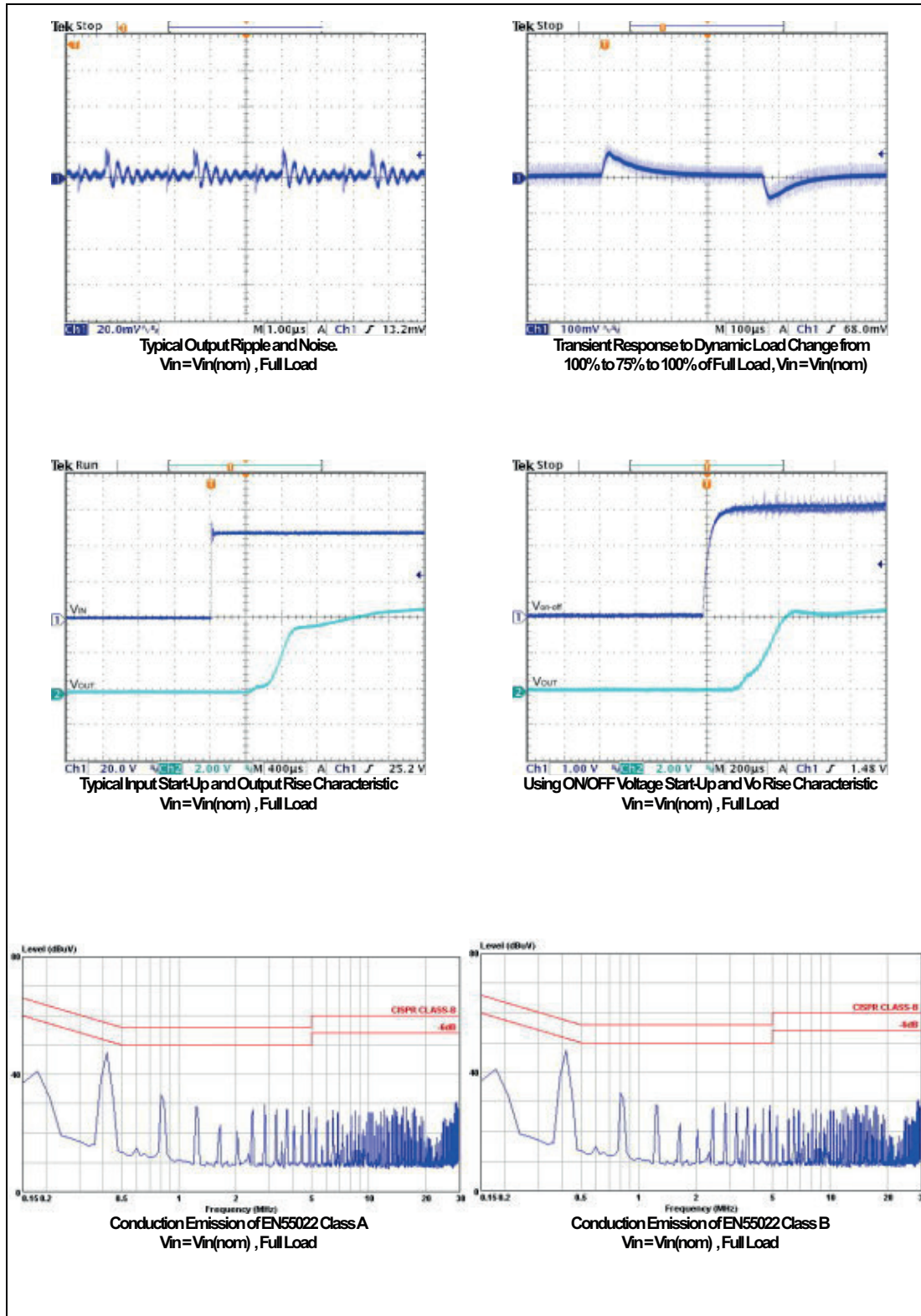



POWERBOX Industrial Line  
 T15W Series  
 15W 4:1 Single Output  
 DC/DC Converter  
 Manual

All test conditions are at 25°C. The figures are identical for PMD15-48S12W

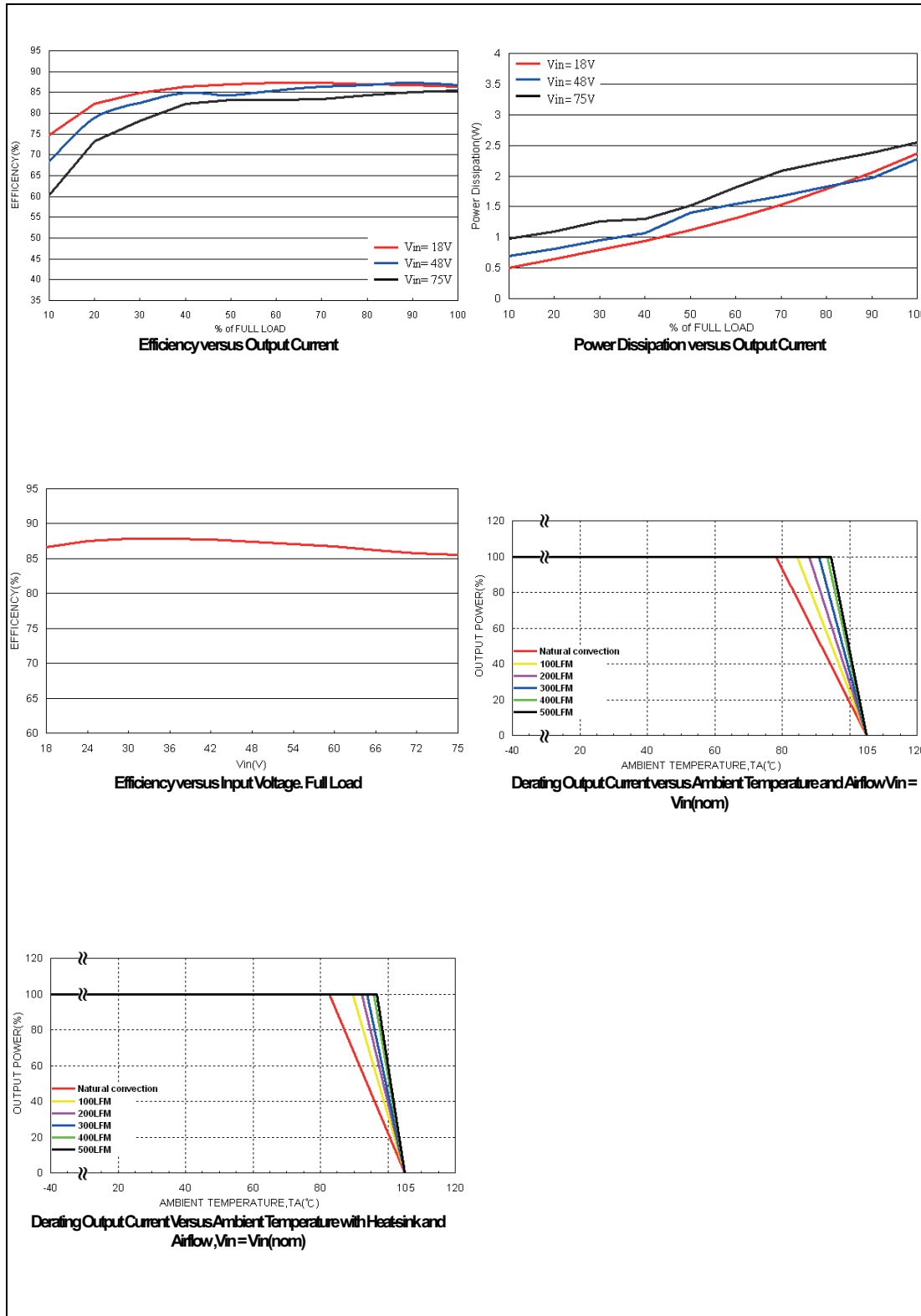

POWERBOX Industrial Line  
 T15W Series  
 15W 4:1 Single Output  
 DC/DC Converter  
 Manual

All test conditions are at 25°C. The figures are identical for PMD15-48S12W

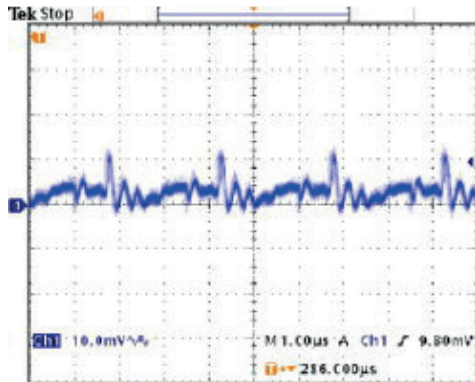

Typical Output Ripple and Noise.  
 $V_{in} = V_{in(nom)}$ , Full Load

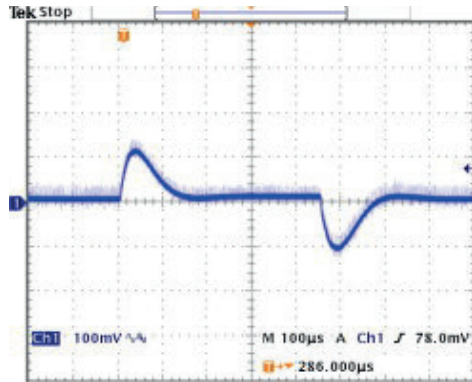

Transient Response to Dynamic Load Change from  
 100% to 75% to 100% of Full Load,  $V_{in} = V_{in(nom)}$

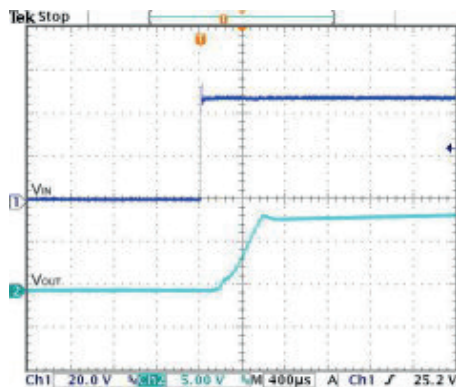

Typical Input Start-Up and Output Rise Characteristic  
 $V_{in} = V_{in(nom)}$ , Full Load

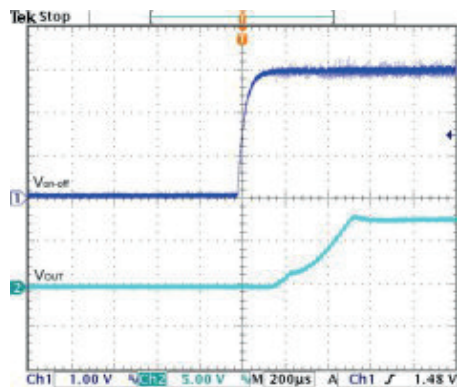

Using ON/OFF Voltage Start-Up and  $V_o$  Rise Characteristic  
 $V_{in} = V_{in(nom)}$ , Full Load

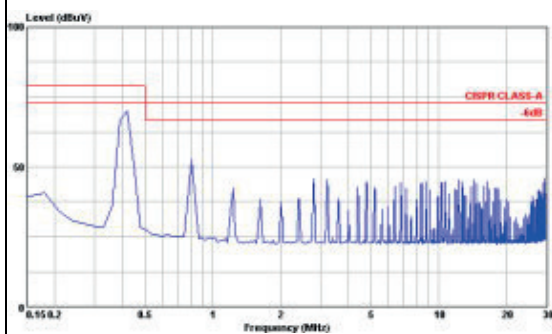

Conduction Emission of EN55022 Class A  
 $V_{in} = V_{in(nom)}$ , Full Load

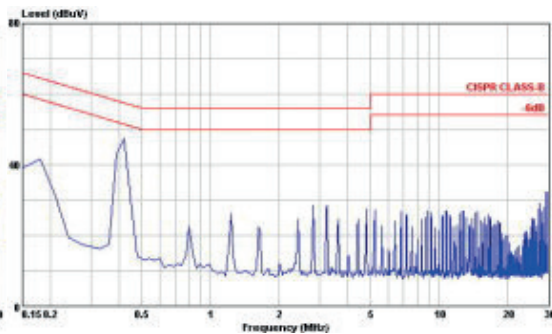

Conduction Emission of EN55022 Class B  
 $V_{in} = V_{in(nom)}$ , Full Load

POWERBOX Industrial Line  
 T15W Series  
 15W 4:1 Single Output  
 DC/DC Converter  
 Manual

All test conditions are at 25°C. The figures are identical for PMD15-48S15W

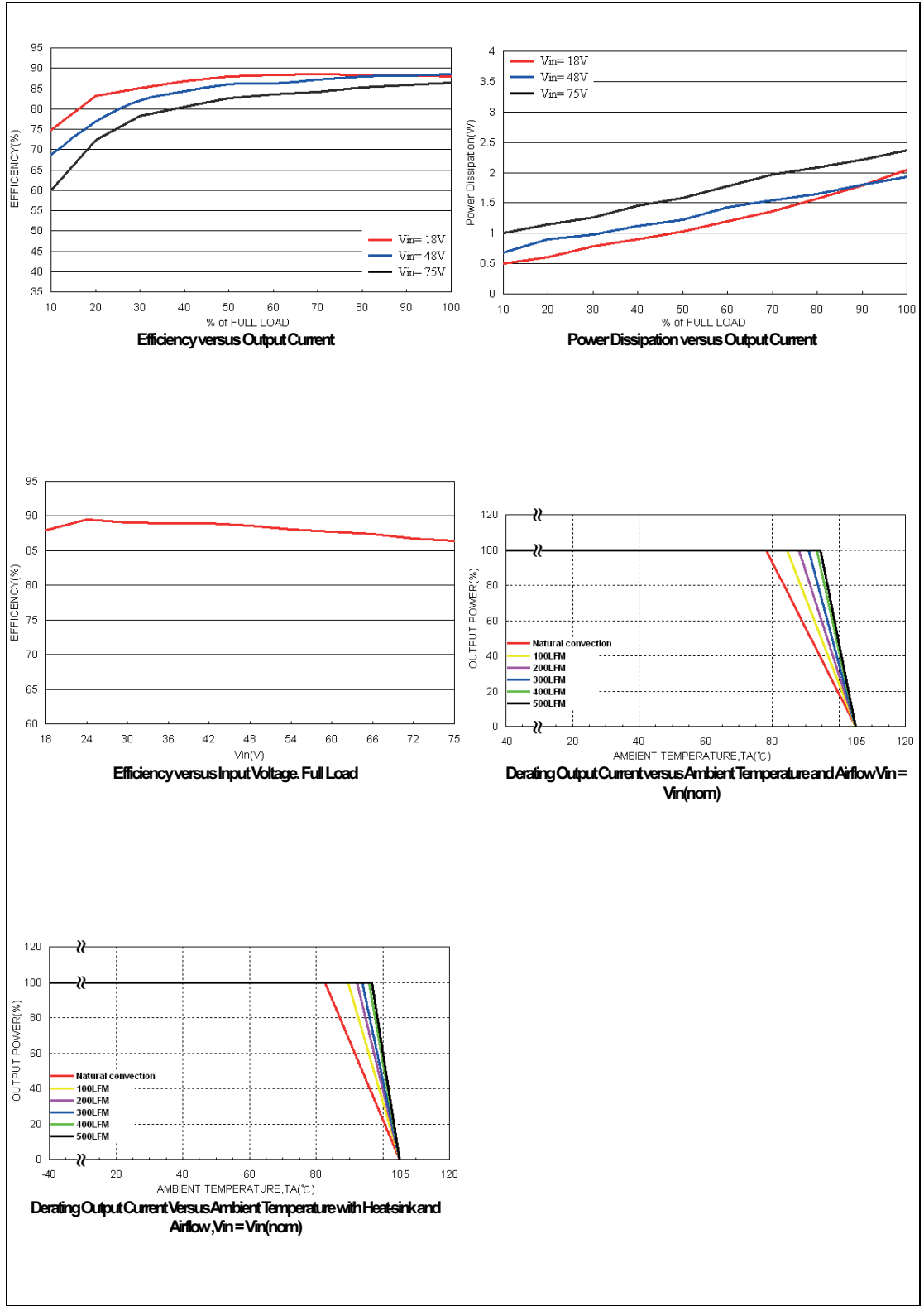

All test conditions are at 25°C. The figures are identical for PMD15-48S15W

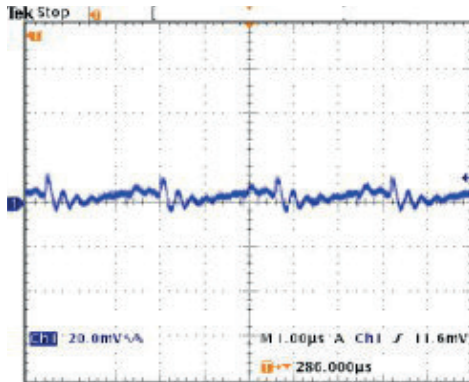

Typical Output Ripple and Noise.  
 $V_{in} = V_{in}(nom)$ , Full Load

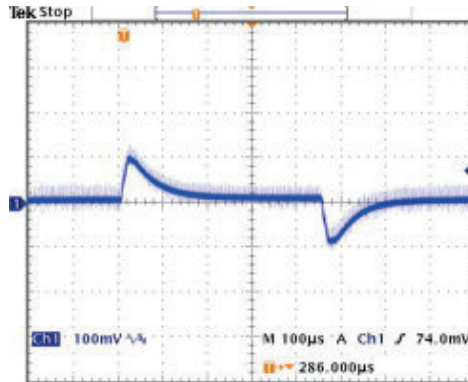

Transient Response to Dynamic Load Change from  
 100% to 75% to 100% of Full Load,  $V_{in} = V_{in}(nom)$

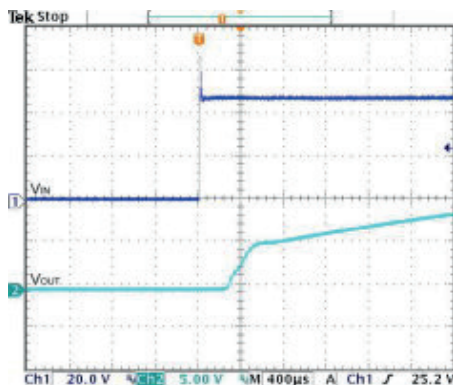

Typical Input Start-Up and Output Rise Characteristic  
 $V_{in} = V_{in}(nom)$ , Full Load

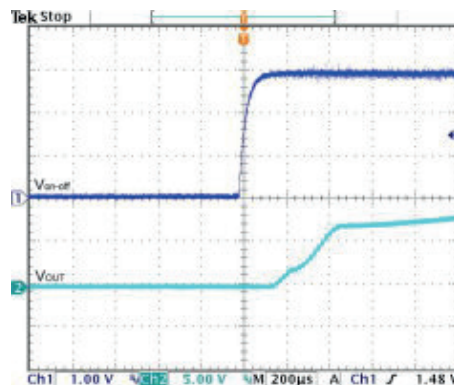

Using ON/OFF Voltage Start-Up and  $V_o$  Rise Characteristic  
 $V_{in} = V_{in}(nom)$ , Full Load

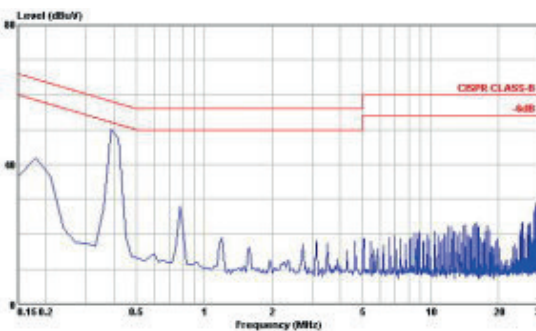

Conduction Emission of EN55022 Class A  
 $V_{in} = V_{in}(nom)$ , Full Load

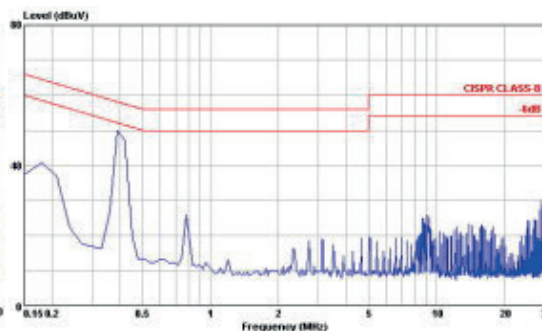

Conduction Emission of EN55022 Class B  
 $V_{in} = V_{in}(nom)$ , Full Load

### Input Source Impedance

The power module should be connected to a low impedance input source. Highly inductive source impedance can affect the stability of the power module. Input external L-C filter is recommended to minimize input reflected ripple current. The inductor is simulated source impedance of  $12\mu\text{H}$  and capacitor is Nippon chemi-con KZE series  $100\mu\text{F}/100\text{V}$ . The capacitor must as close as possible to the input terminals of the power module for lower impedance.

### Output Over Current Protection

When excessive output currents occur in the system, circuit protection is required on all power supplies. Normally, overload current is maintained at approximately 150 percent of rated current for T15W-S SERIES.

Hiccup-mode is a method of operation in a power supply whose purpose is to protect the power supply from being damaged during an over-current fault condition. It also enables the power supply to restart when the fault is removed. There are other ways of protecting the power supply when it is over-loaded, such as the maximum current limiting or current foldback methods.

One of the problems resulting from over current is that excessive heat may be generated in power devices, especially MOSFET and Schottky diodes and the temperature of those devices may exceed their specified limits. A protection mechanism has to be used to prevent those power devices from being damaged.

The operation of hiccup is as follows. When the current sense circuit sees an over-current event, the controller shuts off the power supply for a given time and then tries to start up the power supply again. If the overload condition has been removed, the power supply will start up and operate normally, otherwise, the controller will see another over-current event and shut off the power supply again, repeating the previous cycle. Hiccup operation has none of the drawbacks of the other two protection methods, although its circuit is more complicated because it requires a timing circuit. The excess heat due to overload lasts for only a short duration in the hiccup cycle, hence the junction temperature of the power devices is much lower.

The hiccup operation can be done in various ways. For example, one can start hiccup operation any time an over-current event is detected, or prohibit hiccup during a designated start-up is usually larger than during normal operation and it is easier for an over-current event is detected, or prohibit hiccup during a designated start-up interval (usually a few milliseconds). The reason for the latter operation is that during start-up, the power supply needs to provide extra current to charge up the output capacitor. Thus the current demand during start-up is usually larger than during normal operation and it is easier for an over-current event to

occur. If the power supply starts to hiccup once there is an over-current, it might never start up successfully. Hiccup mode protection will give the best protection for a power supply against over current situations, since it will limit the average current to the load at a low level, so reducing power dissipation and case temperature in the power devices.

### Output Over Voltage Protection

The output over-voltage protection consists of output Zener diode that monitors the voltage on the output terminals. If the voltage on the output terminals exceeds the over-voltage protection threshold, then the Zener diode clamps the output voltage.

### Short Circuitry Protection

Continuous, hiccup and auto-recovery mode. During short circuit, converter still shut down. The average current during this condition will be very low and the device can be safety in this condition.

### Thermal Consideration

The power module operates in a variety of thermal environments. However, sufficient cooling should be provided to help ensure reliable operation of the unit. Heat is removed by conduction, convection, and radiation to the surrounding Environment. Proper cooling can be verified by measuring the point as the figure below. The temperature at this location should not exceed  $105^{\circ}\text{C}$ . When Operating, adequate cooling must be provided to maintain the test point temperature at or below  $105^{\circ}\text{C}$ . Although the maximum point Temperature of the power modules is  $105^{\circ}\text{C}$ , you can limit this temperature to a lower value for extremely high reliability.

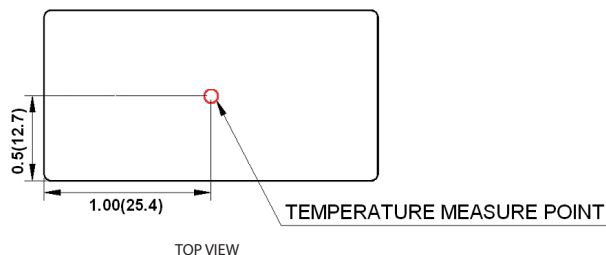

Remote On/Off Control

The Remote CTRL Pin is controlled DC/DC power module to turn on and off, the user must use a switch to control the logic voltage high or low level of the pin referenced to -INPUT. The switch can be open collector transistor, FET and Photo-Couple. The switch must be capable of sinking up to 0.5mA at low-level logic voltage. High-level logic of the CTRL pin signal maximum voltage is allowable leakage current of the switch at 12V is 0.5mA.

Remote ON/OFF implementation circuits

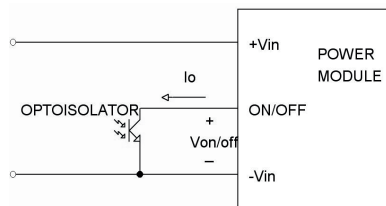

Isolated-Closure Remote On/Off

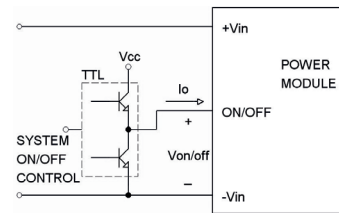

Level Control Using TTL Output

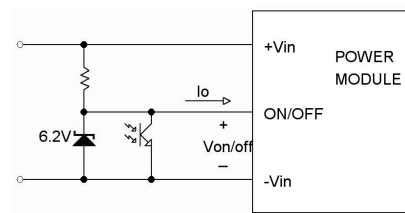

Level Control Using Line Voltage

There are two remote control options available, positive logic and negative logic.

a. The Positive logic structure turned on of the DC/DC module when the CTRL pin is at high-level logic and low-level logic is turned off it.

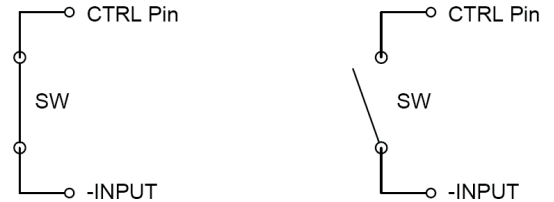

When T15W module is turned off at Low-level logic

When T15W module is turned on at High-level logic

b. The Negative logic structure turned on of the DC/DC module when the CTRL pin is at low-level logic and turned off when at high-level logic.

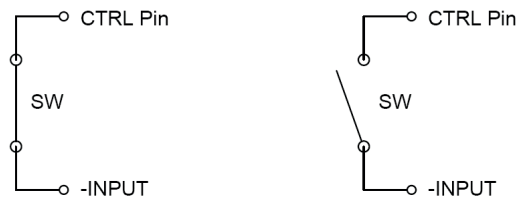

When T15W module is turned on at Low-level logic

When T15W module is turned off at High-level logic

Heat-sink

Equip Heat-sink (7G-0020C-F) for lower temperature and higher reliability of the module. Considering space and air-flow is the way to choose which heat-sink is needed.

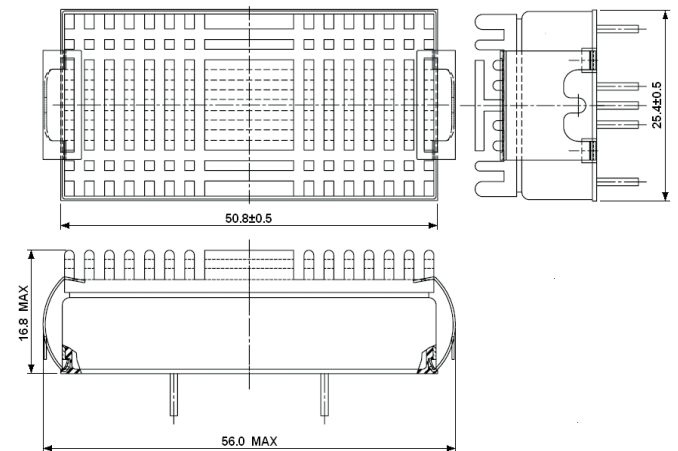

Mechanical Data

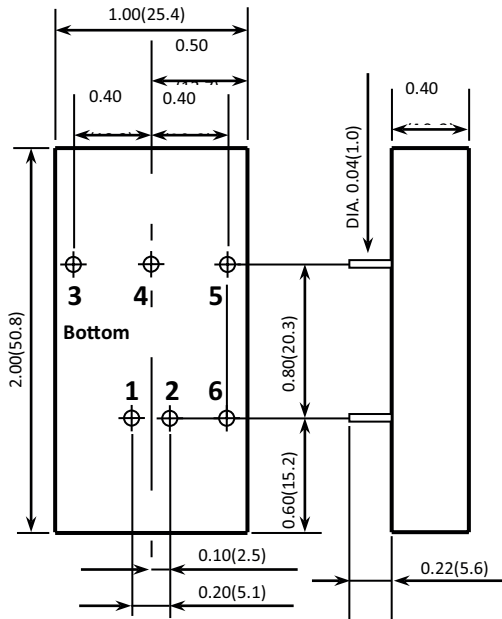

- All dimensions in Inch (mm)
- Pin pitch tolerance  $\pm 0.0014(0.35)$
- Tolerance:  $x.xx \pm 0.02$  ( $x.x \pm 0.5$ )  
 $x.xxx \pm 0.01$  ( $x.xx \pm 0.25$ )

Pin Connection

Pin	Define
1	+ INPUT
2	- INPUT
3	+ OUTPUT
4	NO PIN
5	- OUTPUT
6	CTRL (Option)

Recommended Pad Layout

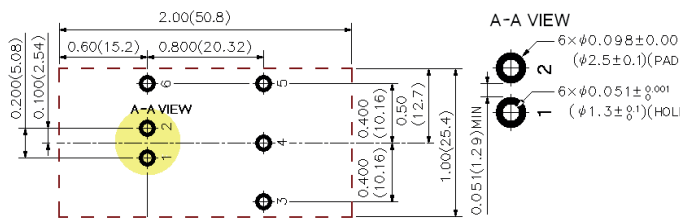

- All dimensions in Inch (mm)  
Tolerance:  $x.xx \pm 0.02$  ( $x.x \pm 0.5$ )  
 $x.xxx \pm 0.01$  ( $x.xx \pm 0.25$ )
- Pin pitch tolerance  $\pm 0.01(0.25)$

Soldering and Reflow Considerations

Lead free wave solder profile for T15W DIP type

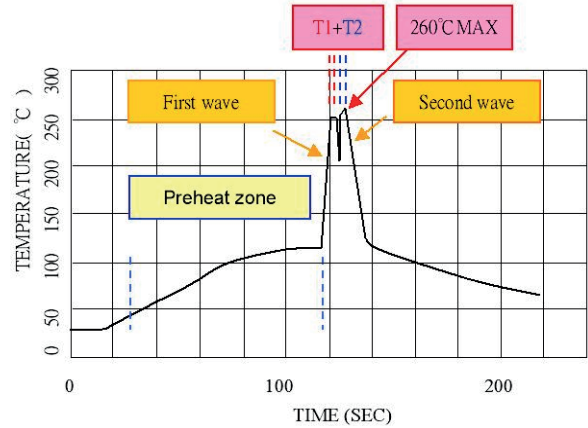

Zone	Reference Parameter
Preheat zone	Rise temp. speed : 3°C / sec max. Preheat temp. : 100~130°C
Actual heating	Peak temp. : 250~260°C Peak time (T1+T2 time) : 4~6 sec

Reference Solder : Sn-Ag-Cu , Sn-Cu

Hand Welding : Soldering iron : Power 90W  
Welding Time : 2~4 sec  
Temp. : 380~400°C

Packaging Information

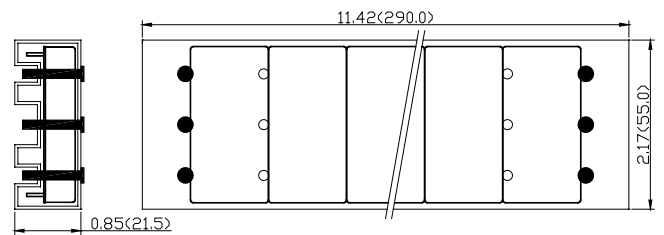

10 PCS per Tube

All dimensions in inch (mm)

POWERBOX Industrial Line  
T15W Series  
15W 4:1 Single Output  
DC/DC Converter  
Manual

### Safety and Installation Instruction

#### Fusing Consideration

Caution: This power module is not internally fused. An input line fuse must always be used.

This encapsulated power module can be used in a wide variety of applications, ranging from simple stand-alone operation to an integrated part of sophisticated power architecture. To maximum flexibility, internal fusing is not included, however, to achieve maximum safety and system protection, always use an input line fuse. The safety agencies require a slow-blow fuse with maximum rating of 5A. Based on the information provided in this data sheet on Inrush energy and maximum dc input current, the same type of fuse with lower rating can be used. Refer to the fuse manufacturer's data for further information.

### MTBF and Reliability

The MTBF of T15W SINGLE-SERIES of DC/DC converters has been calculated using MIL-HDBK 217F @Ta=25°C, FULL LOAD. The resulting figure for MTBF is  $2.430 \times 10^6$  hours.



**Recommended external EMI filter for EN55022 Class A**

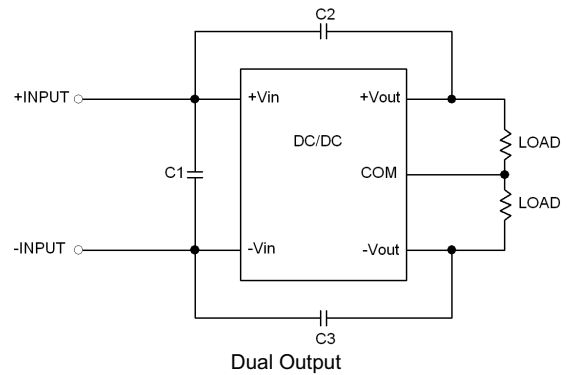
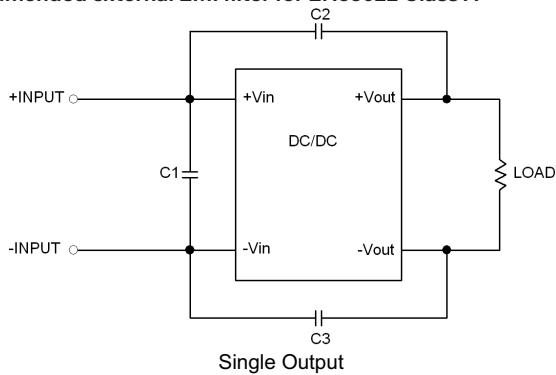

Model	C1	C2	C3
PMD15-24□□□W	N/A	1000pF/2kV 1206 MLCC	1000pF/2kV 1206 MLCC
PMD15-48□□□W	1μF/100V 1210 MLCC	1000pF/2kV 1206 MLCC	1000pF/2kV 1206 MLCC

**Recommended external EMI filter for EN55022 Class B**

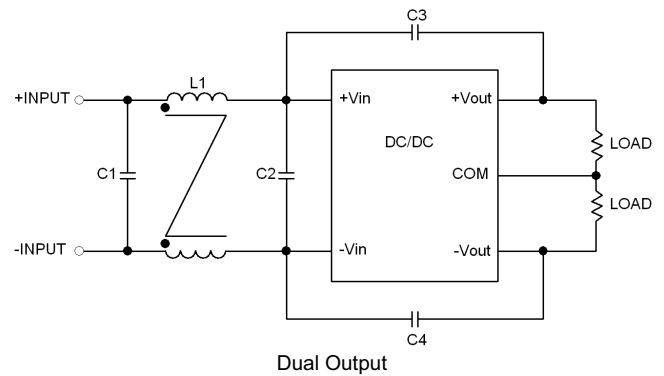
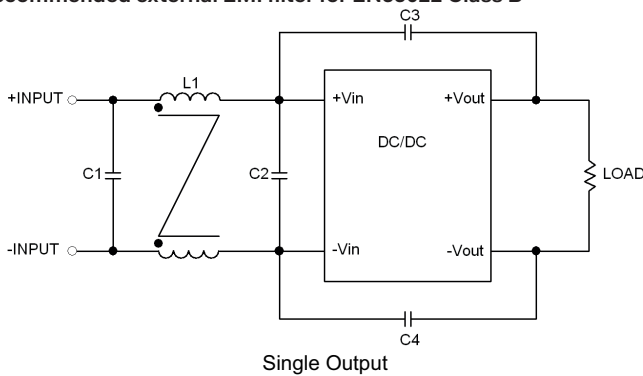

Model	C1	C2	C3, C4	L1
PMD15-24□□□W	2.2μF/50V 1812 MLCC	N/A	1000pF/2kV 1206 MLCC	450μH Common Shoke PMT-048
PMD15-48□□□W	2.2μF/100V 1812 MLCC	2.2μF/100V 1812 MLCC	1000pF/2kV 1206 MLCC	325μH Common Shoke PMT-050