

# Harness

## Mating harness

Model	Harness model #	
	Input	Output
LHA30F	H-IN-5 or H-IN-10	H-OU-9
LHA50F		H-OU-9
LHA75F		H-OU-18
LHA100F		H-OU-18
LHA150F		H-OU-18
LHA300F		H-OU-46
*LHA300F		H-OU-10
LCA10S	H-IN-4	H-OU-7
LCA15S	H-IN-4	H-OU-8
LCA30S	H-IN-5 or H-IN-10	H-OU-9
LCA50S *LGA50A		H-OU-9
LCA75S *LGA75A		H-OU-18
LCA100S *LGA100A		H-OU-10
LCA150S, *LGA150A		H-OU-11
*LGA240A, *LFA300F, *LFP300F		H-OU-12
SNA-01,-03		H-IN-14
SNA-06	H-OU-8	H-OU-8
SNR-10	H-OU-9	H-OU-9
	H-OU-18	H-OU-18

Model	Harness model #		
	Input	Output	
LDA10F	H-IN-5 or H-IN-10	H-OU-8	
LDA15F		H-OU-8	
LDA30F, *LFA30F		H-OU-9	
LDA50F, LEA50F, *LFA50F		H-OU-9	
LDA75F, LEA75F, *LFA75F		H-OU-18	
LDA100W, LEA100F, *LFP100F, *LFA100F		H-OU-10	
*LMA100F, LEP100F, 150F, 240F			
LDA150W, LEA150F, *LFP150F, *LFA150F, *LFA240F, *LFP240F, *LMA150F, *LMA240F			
*LFA10F		H-OU-11	
*LFA15F		H-OU-12	
*LDA300W		H-OU-34	
		H-OU-34	
		H-IN-7	H-OU-22

\* Optional : connector type "-J" (LDA300W)  
 \* Optional : connector type "-J1" (LGA50A, 75A, 100A, 150A, 240A)  
 \* Optional : connector type "-J1" (LFA10F, 15F, 30F, 50F, 75F, 100F, 150F, 240F, 300F)  
 \* Optional : connector type "-J1" (LFP100F, 150F, 240F, 300F)  
 \* Optional : connector type "-J1" (LMA100F, 150F, 240F)  
 \* Optional : connector type "-J5" (LHA300F)

LCA Series  
 LGA Series  
 LDA Series  
 LEA Series  
 LEP Series  
 LFA Series  
 LHA Series  
 LFP Series  
 LMA Series  
 SNA Series  
 SNR Series

<p>●Model number <b>H-IN-4</b> Housing : XHP-7 (J.S.T.) Pin : SXH-001T-P0.6 (J.S.T.) Weight : 10g max</p>	<p>●Type</p>	<p>●Wire</p> <table border="1"> <thead> <tr><th>Pin #</th><th>Wire</th><th>AWG</th><th>Color</th><th>Length ℓ (mm)</th></tr> </thead> <tbody> <tr><td>1</td><td>UL1007</td><td>22</td><td>black</td><td>500</td></tr> <tr><td>2, 3</td><td></td><td></td><td></td><td></td></tr> <tr><td>4</td><td>UL1007</td><td>22</td><td>white</td><td>500</td></tr> <tr><td>5, 6</td><td></td><td></td><td></td><td></td></tr> <tr><td>7</td><td>UL1007</td><td>22</td><td>green</td><td>500</td></tr> </tbody> </table>	Pin #	Wire	AWG	Color	Length ℓ (mm)	1	UL1007	22	black	500	2, 3					4	UL1007	22	white	500	5, 6					7	UL1007	22	green	500
Pin #	Wire	AWG	Color	Length ℓ (mm)																												
1	UL1007	22	black	500																												
2, 3																																
4	UL1007	22	white	500																												
5, 6																																
7	UL1007	22	green	500																												
<p>●Model number <b>H-IN-5</b> Housing : VHR-5N (J.S.T.) Pin : SVH-21T-P1.1 (J.S.T.) Weight : 30g max</p>	<p>●Type</p>	<p>●Wire</p> <table border="1"> <thead> <tr><th>Pin #</th><th>Wire</th><th>AWG</th><th>Color</th><th>Length ℓ (mm)</th></tr> </thead> <tbody> <tr><td>1</td><td>UL1015</td><td>18</td><td>black</td><td>500</td></tr> <tr><td>2</td><td></td><td></td><td></td><td></td></tr> <tr><td>3</td><td>UL1015</td><td>18</td><td>white</td><td>500</td></tr> <tr><td>4</td><td></td><td></td><td></td><td></td></tr> <tr><td>5</td><td>UL1015</td><td>18</td><td>green</td><td>500</td></tr> </tbody> </table>	Pin #	Wire	AWG	Color	Length ℓ (mm)	1	UL1015	18	black	500	2					3	UL1015	18	white	500	4					5	UL1015	18	green	500
Pin #	Wire	AWG	Color	Length ℓ (mm)																												
1	UL1015	18	black	500																												
2																																
3	UL1015	18	white	500																												
4																																
5	UL1015	18	green	500																												
<p>●Model number <b>H-IN-7</b> Housing : 1-178128-5 (Tyco Electronics) Pin : 1-175218-2 or 1-175218-3 (Tyco Electronics) Weight : 35g max</p>	<p>●Type</p>	<p>●Wire</p> <table border="1"> <thead> <tr><th>Pin #</th><th>Wire</th><th>AWG</th><th>Color</th><th>Length ℓ (mm)</th></tr> </thead> <tbody> <tr><td>1</td><td>UL1015</td><td>18</td><td>white</td><td>500</td></tr> <tr><td>2</td><td></td><td></td><td></td><td></td></tr> <tr><td>3</td><td>UL1015</td><td>18</td><td>black</td><td>500</td></tr> <tr><td>4</td><td></td><td></td><td></td><td></td></tr> <tr><td>5</td><td>UL1015</td><td>18</td><td>green/yellow</td><td>500</td></tr> </tbody> </table>	Pin #	Wire	AWG	Color	Length ℓ (mm)	1	UL1015	18	white	500	2					3	UL1015	18	black	500	4					5	UL1015	18	green/yellow	500
Pin #	Wire	AWG	Color	Length ℓ (mm)																												
1	UL1015	18	white	500																												
2																																
3	UL1015	18	black	500																												
4																																
5	UL1015	18	green/yellow	500																												
<p>●Model number <b>H-IN-10</b> Housing : VHR-5N (J.S.T.) Pin : SVH-21T-P1.1 (J.S.T.) Weight : 30g max</p>	<p>●Type</p>	<p>●Wire</p> <table border="1"> <thead> <tr><th>Pin #</th><th>Wire</th><th>AWG</th><th>Color</th><th>Length ℓ (mm)</th></tr> </thead> <tbody> <tr><td>1</td><td>UL1015</td><td>18</td><td>black</td><td>500</td></tr> <tr><td>2</td><td></td><td></td><td></td><td></td></tr> <tr><td>3</td><td>UL1015</td><td>18</td><td>white</td><td>500</td></tr> <tr><td>4</td><td></td><td></td><td></td><td></td></tr> <tr><td>5</td><td>UL1015</td><td>18</td><td>green/yellow</td><td>500</td></tr> </tbody> </table>	Pin #	Wire	AWG	Color	Length ℓ (mm)	1	UL1015	18	black	500	2					3	UL1015	18	white	500	4					5	UL1015	18	green/yellow	500
Pin #	Wire	AWG	Color	Length ℓ (mm)																												
1	UL1015	18	black	500																												
2																																
3	UL1015	18	white	500																												
4																																
5	UL1015	18	green/yellow	500																												
<p>●Model number <b>H-IN-14</b> Housing : VHR-8N (J.S.T.) Pin : SVH-21T-P1.1 (J.S.T.) Weight : 60g max</p>	<p>●Type</p>	<p>●Wire</p> <table border="1"> <thead> <tr><th>Pin #</th><th>Wire</th><th>AWG</th><th>Color</th><th>Length ℓ (mm)</th></tr> </thead> <tbody> <tr><td>1, 2</td><td>UL1015</td><td>18</td><td>black</td><td>500</td></tr> <tr><td>3</td><td></td><td></td><td></td><td></td></tr> <tr><td>4, 5</td><td>UL1015</td><td>18</td><td>white</td><td>500</td></tr> <tr><td>6</td><td></td><td></td><td></td><td></td></tr> <tr><td>7, 8</td><td>UL1015</td><td>18</td><td>green</td><td>500</td></tr> </tbody> </table>	Pin #	Wire	AWG	Color	Length ℓ (mm)	1, 2	UL1015	18	black	500	3					4, 5	UL1015	18	white	500	6					7, 8	UL1015	18	green	500
Pin #	Wire	AWG	Color	Length ℓ (mm)																												
1, 2	UL1015	18	black	500																												
3																																
4, 5	UL1015	18	white	500																												
6																																
7, 8	UL1015	18	green	500																												
<p>●Model number <b>H-OU-7</b> Housing : XHP-2 (J.S.T.) Pin : SXH-001T-P0.6 (J.S.T.) Weight : 7g max</p>	<p>●Type</p>	<p>●Wire</p> <table border="1"> <thead> <tr><th>Pin #</th><th>Wire</th><th>AWG</th><th>Color</th><th>Length ℓ (mm)</th></tr> </thead> <tbody> <tr><td>1</td><td>UL1007</td><td>22</td><td>black</td><td>500</td></tr> <tr><td>2</td><td>UL1007</td><td>22</td><td>red</td><td>500</td></tr> </tbody> </table>	Pin #	Wire	AWG	Color	Length ℓ (mm)	1	UL1007	22	black	500	2	UL1007	22	red	500															
Pin #	Wire	AWG	Color	Length ℓ (mm)																												
1	UL1007	22	black	500																												
2	UL1007	22	red	500																												
<p>●Model number <b>H-OU-8</b> Housing : XHP-4 (J.S.T.) Pin : SXH-001T-P0.6 (J.S.T.) Weight : 15g max</p>	<p>●Type</p>	<p>●Wire</p> <table border="1"> <thead> <tr><th>Pin #</th><th>Wire</th><th>AWG</th><th>Color</th><th>Length ℓ (mm)</th></tr> </thead> <tbody> <tr><td>1</td><td>UL1007</td><td>22</td><td>black</td><td>500</td></tr> <tr><td>2</td><td>UL1007</td><td>22</td><td>black</td><td>500</td></tr> <tr><td>3</td><td>UL1007</td><td>22</td><td>red</td><td>500</td></tr> <tr><td>4</td><td>UL1007</td><td>22</td><td>red</td><td>500</td></tr> </tbody> </table>	Pin #	Wire	AWG	Color	Length ℓ (mm)	1	UL1007	22	black	500	2	UL1007	22	black	500	3	UL1007	22	red	500	4	UL1007	22	red	500					
Pin #	Wire	AWG	Color	Length ℓ (mm)																												
1	UL1007	22	black	500																												
2	UL1007	22	black	500																												
3	UL1007	22	red	500																												
4	UL1007	22	red	500																												

<p>●Model number <b>H-OU-9</b> Housing : VHR-4N (J.S.T.) Pin : SVH-21T-P1.1 (J.S.T.) Weight : 40g max</p>	<p>●Type</p>	<p>●Wire</p> <table border="1"> <thead> <tr> <th>Pin #</th> <th>Wire</th> <th>AWG</th> <th>Color</th> <th>Length ℓ (mm)</th> </tr> </thead> <tbody> <tr> <td>1</td> <td>UL1015</td> <td>18</td> <td>black</td> <td>500</td> </tr> <tr> <td>2</td> <td>UL1015</td> <td>18</td> <td>black</td> <td>500</td> </tr> <tr> <td>3</td> <td>UL1015</td> <td>18</td> <td>red</td> <td>500</td> </tr> <tr> <td>4</td> <td>UL1015</td> <td>18</td> <td>red</td> <td>500</td> </tr> </tbody> </table>	Pin #	Wire	AWG	Color	Length ℓ (mm)	1	UL1015	18	black	500	2	UL1015	18	black	500	3	UL1015	18	red	500	4	UL1015	18	red	500
Pin #	Wire	AWG	Color	Length ℓ (mm)																							
1	UL1015	18	black	500																							
2	UL1015	18	black	500																							
3	UL1015	18	red	500																							
4	UL1015	18	red	500																							
<p>●Model number <b>H-OU-10</b> Housing : VHR-8N (J.S.T.) Pin : SVH-21T-P1.1 (J.S.T.) Weight : 80g max</p>	<p>●Type</p>	<p>●Wire</p> <table border="1"> <thead> <tr> <th>Pin #</th> <th>Wire</th> <th>AWG</th> <th>Color</th> <th>Length ℓ (mm)</th> </tr> </thead> <tbody> <tr> <td>1 - 4</td> <td>UL1015</td> <td>18</td> <td>black</td> <td>500</td> </tr> <tr> <td>5 - 8</td> <td>UL1015</td> <td>18</td> <td>red</td> <td>500</td> </tr> </tbody> </table>	Pin #	Wire	AWG	Color	Length ℓ (mm)	1 - 4	UL1015	18	black	500	5 - 8	UL1015	18	red	500										
Pin #	Wire	AWG	Color	Length ℓ (mm)																							
1 - 4	UL1015	18	black	500																							
5 - 8	UL1015	18	red	500																							
<p>●Model number <b>H-OU-11</b> Housing : VHR-6N (J.S.T.) Pin : SVH-21T-P1.1 (J.S.T.) Weight : 60g max</p>	<p>●Type</p>	<p>●Wire</p> <table border="1"> <thead> <tr> <th>Pin #</th> <th>Wire</th> <th>AWG</th> <th>Color</th> <th>Length ℓ (mm)</th> </tr> </thead> <tbody> <tr> <td>1 - 6</td> <td>UL1015</td> <td>18</td> <td>red</td> <td>500</td> </tr> </tbody> </table>	Pin #	Wire	AWG	Color	Length ℓ (mm)	1 - 6	UL1015	18	red	500															
Pin #	Wire	AWG	Color	Length ℓ (mm)																							
1 - 6	UL1015	18	red	500																							
<p>●Model number <b>H-OU-12</b> Housing : VHR-7N (J.S.T.) Pin : SVH-21T-P1.1 (J.S.T.) Weight : 70g max</p>	<p>●Type</p>	<p>●Wire</p> <table border="1"> <thead> <tr> <th>Pin #</th> <th>Wire</th> <th>AWG</th> <th>Color</th> <th>Length ℓ (mm)</th> </tr> </thead> <tbody> <tr> <td>1 - 7</td> <td>UL1015</td> <td>18</td> <td>black</td> <td>500</td> </tr> </tbody> </table>	Pin #	Wire	AWG	Color	Length ℓ (mm)	1 - 7	UL1015	18	black	500															
Pin #	Wire	AWG	Color	Length ℓ (mm)																							
1 - 7	UL1015	18	black	500																							
<p>●Model number <b>H-OU-18</b> Housing : VHR-6N (J.S.T.) Pin : SVH-21T-P1.1 (J.S.T.) Weight : 60g max</p>	<p>●Type</p>	<p>●Wire</p> <table border="1"> <thead> <tr> <th>Pin #</th> <th>Wire</th> <th>AWG</th> <th>Color</th> <th>Length ℓ (mm)</th> </tr> </thead> <tbody> <tr> <td>1 - 3</td> <td>UL1015</td> <td>18</td> <td>black</td> <td>500</td> </tr> <tr> <td>4 - 6</td> <td>UL1015</td> <td>18</td> <td>red</td> <td>500</td> </tr> </tbody> </table>	Pin #	Wire	AWG	Color	Length ℓ (mm)	1 - 3	UL1015	18	black	500	4 - 6	UL1015	18	red	500										
Pin #	Wire	AWG	Color	Length ℓ (mm)																							
1 - 3	UL1015	18	black	500																							
4 - 6	UL1015	18	red	500																							
<p>●Model number <b>H-OU-22</b> Housing : 1-178288-8 (Tyco Electronics) Pin : 1-175218-2 or 1-175218-3 (Tyco Electronics) Weight : 100g max</p>	<p>●Type</p>	<p>●Wire</p> <table border="1"> <thead> <tr> <th>Pin #</th> <th>Wire</th> <th>AWG</th> <th>Color</th> <th>Length ℓ (mm)</th> </tr> </thead> <tbody> <tr> <td>1 - 5</td> <td>UL1015</td> <td>18</td> <td>black</td> <td>500</td> </tr> <tr> <td>6 - 10</td> <td>UL1015</td> <td>18</td> <td>red</td> <td>500</td> </tr> </tbody> </table>	Pin #	Wire	AWG	Color	Length ℓ (mm)	1 - 5	UL1015	18	black	500	6 - 10	UL1015	18	red	500										
Pin #	Wire	AWG	Color	Length ℓ (mm)																							
1 - 5	UL1015	18	black	500																							
6 - 10	UL1015	18	red	500																							
<p>●Model number <b>H-OU-34</b> Housing : VHR-2N (J.S.T.) Pin : SVH-21T-P1.1 (J.S.T.) Weight : 20g max</p>	<p>●Type</p>	<p>●Wire</p> <table border="1"> <thead> <tr> <th>Pin #</th> <th>Wire</th> <th>AWG</th> <th>Color</th> <th>Length ℓ (mm)</th> </tr> </thead> <tbody> <tr> <td>1</td> <td>UL1015</td> <td>18</td> <td>black</td> <td>500</td> </tr> <tr> <td>2</td> <td>UL1015</td> <td>18</td> <td>red</td> <td>500</td> </tr> </tbody> </table>	Pin #	Wire	AWG	Color	Length ℓ (mm)	1	UL1015	18	black	500	2	UL1015	18	red	500										
Pin #	Wire	AWG	Color	Length ℓ (mm)																							
1	UL1015	18	black	500																							
2	UL1015	18	red	500																							
<p>●Model number <b>H-OU-46</b> Housing : VHR-10N (J.S.T.) Pin : SVH-21T-P1.1 (J.S.T.) Weight : 100g max</p>	<p>●Type</p>	<p>●Wire</p> <table border="1"> <thead> <tr> <th>Pin #</th> <th>Wire</th> <th>AWG</th> <th>Color</th> <th>Length ℓ (mm)</th> </tr> </thead> <tbody> <tr> <td>1 - 5</td> <td>UL1015</td> <td>18</td> <td>black</td> <td>500</td> </tr> <tr> <td>6 - 10</td> <td>UL1015</td> <td>18</td> <td>red</td> <td>500</td> </tr> </tbody> </table>	Pin #	Wire	AWG	Color	Length ℓ (mm)	1 - 5	UL1015	18	black	500	6 - 10	UL1015	18	red	500										
Pin #	Wire	AWG	Color	Length ℓ (mm)																							
1 - 5	UL1015	18	black	500																							
6 - 10	UL1015	18	red	500																							

Mating harness

LGA Series  
LFA Series  
LHA Series  
LFP Series  
LMA Series

\*Optional:connector type "-J4"  
(LHA30F,50F,75F,100F,150F,300F)

Model	Harness model #	
	Input	Output
LFA10F	H-IN-12	H-OU-33
LFA15F		H-OU-33
LFA30F, *LHA30F		H-OU-28
LFA50F, LGA50A, *LHA50F		H-OU-28
LFA75F, LGA75A, *LHA75F, *LHA100F, *LHA150F		H-OU-29
LFP100F, LFA100F, LGA100A LMA100F		H-OU-30
LFP150F, LFA150F, LGA150A, LFA240F, LFP240F, LMA150F LMA240F		H-OU-31
		H-OU-32
*LHA300F		H-OU-47
LGA240A, LFA300F LFP300F	H-IN-13	H-OU-31 H-OU-32

<p>●Model number <b>H-IN-12</b> Housing : 1-1123722-5 (Tyco Electronics) Pin : 1123721-1 or 1318912-1 (Tyco Electronics) Weight : 30g max</p>	<p>●Type</p>	<p>●Wire</p> <table border="1"> <thead> <tr> <th>Pin #</th> <th>Wire</th> <th>AWG</th> <th>Color</th> <th>Length ℓ (mm)</th> </tr> </thead> <tbody> <tr> <td>1</td> <td>UL1015</td> <td>18</td> <td>black</td> <td>500</td> </tr> <tr> <td>2</td> <td></td> <td></td> <td></td> <td></td> </tr> <tr> <td>3</td> <td>UL1015</td> <td>18</td> <td>white</td> <td>500</td> </tr> <tr> <td>4</td> <td></td> <td></td> <td></td> <td></td> </tr> <tr> <td>5</td> <td>UL1015</td> <td>18</td> <td>green</td> <td>500</td> </tr> </tbody> </table>	Pin #	Wire	AWG	Color	Length ℓ (mm)	1	UL1015	18	black	500	2					3	UL1015	18	white	500	4					5	UL1015	18	green	500
Pin #	Wire	AWG	Color	Length ℓ (mm)																												
1	UL1015	18	black	500																												
2																																
3	UL1015	18	white	500																												
4																																
5	UL1015	18	green	500																												
<p>●Model number <b>H-IN-13</b> Housing : 1-1123722-8 (Tyco Electronics) Pin : 1123721-1 or 1318912-1 (Tyco Electronics) Weight : 55g max</p>	<p>●Type</p>	<p>●Wire</p> <table border="1"> <thead> <tr> <th>Pin #</th> <th>Wire</th> <th>AWG</th> <th>Color</th> <th>Length ℓ (mm)</th> </tr> </thead> <tbody> <tr> <td>1,2</td> <td>UL1015</td> <td>18</td> <td>black</td> <td>500</td> </tr> <tr> <td>3</td> <td></td> <td></td> <td></td> <td></td> </tr> <tr> <td>4,5</td> <td>UL1015</td> <td>18</td> <td>white</td> <td>500</td> </tr> <tr> <td>6</td> <td></td> <td></td> <td></td> <td></td> </tr> <tr> <td>7,8</td> <td>UL1015</td> <td>18</td> <td>green</td> <td>500</td> </tr> </tbody> </table>	Pin #	Wire	AWG	Color	Length ℓ (mm)	1,2	UL1015	18	black	500	3					4,5	UL1015	18	white	500	6					7,8	UL1015	18	green	500
Pin #	Wire	AWG	Color	Length ℓ (mm)																												
1,2	UL1015	18	black	500																												
3																																
4,5	UL1015	18	white	500																												
6																																
7,8	UL1015	18	green	500																												
<p>●Model number <b>H-OU-28</b> Housing : 1-1123722-4 (Tyco Electronics) Pin : 1123721-1 or 1318912-1 (Tyco Electronics) Weight : 40g max</p>	<p>●Type</p>	<p>●Wire</p> <table border="1"> <thead> <tr> <th>Pin #</th> <th>Wire</th> <th>AWG</th> <th>Color</th> <th>Length ℓ (mm)</th> </tr> </thead> <tbody> <tr> <td>1</td> <td>UL1015</td> <td>18</td> <td>black</td> <td>500</td> </tr> <tr> <td>2</td> <td>UL1015</td> <td>18</td> <td>black</td> <td>500</td> </tr> <tr> <td>3</td> <td>UL1015</td> <td>18</td> <td>red</td> <td>500</td> </tr> <tr> <td>4</td> <td>UL1015</td> <td>18</td> <td>red</td> <td>500</td> </tr> </tbody> </table>	Pin #	Wire	AWG	Color	Length ℓ (mm)	1	UL1015	18	black	500	2	UL1015	18	black	500	3	UL1015	18	red	500	4	UL1015	18	red	500					
Pin #	Wire	AWG	Color	Length ℓ (mm)																												
1	UL1015	18	black	500																												
2	UL1015	18	black	500																												
3	UL1015	18	red	500																												
4	UL1015	18	red	500																												
<p>●Model number <b>H-OU-29</b> Housing : 1-1123722-6 (Tyco Electronics) Pin : 1123721-1 or 1318912-1 (Tyco Electronics) Weight : 60g max</p>	<p>●Type</p>	<p>●Wire</p> <table border="1"> <thead> <tr> <th>Pin #</th> <th>Wire</th> <th>AWG</th> <th>Color</th> <th>Length ℓ (mm)</th> </tr> </thead> <tbody> <tr> <td>1 - 3</td> <td>UL1015</td> <td>18</td> <td>black</td> <td>500</td> </tr> <tr> <td>4 - 6</td> <td>UL1015</td> <td>18</td> <td>red</td> <td>500</td> </tr> </tbody> </table>	Pin #	Wire	AWG	Color	Length ℓ (mm)	1 - 3	UL1015	18	black	500	4 - 6	UL1015	18	red	500															
Pin #	Wire	AWG	Color	Length ℓ (mm)																												
1 - 3	UL1015	18	black	500																												
4 - 6	UL1015	18	red	500																												
<p>●Model number <b>H-OU-30</b> Housing : 1-1123722-8 (Tyco Electronics) Pin : 1123721-1 or 1318912-1 (Tyco Electronics) Weight : 75g max</p>	<p>●Type</p>	<p>●Wire</p> <table border="1"> <thead> <tr> <th>Pin #</th> <th>Wire</th> <th>AWG</th> <th>Color</th> <th>Length ℓ (mm)</th> </tr> </thead> <tbody> <tr> <td>1 - 4</td> <td>UL1015</td> <td>18</td> <td>black</td> <td>500</td> </tr> <tr> <td>5 - 8</td> <td>UL1015</td> <td>18</td> <td>red</td> <td>500</td> </tr> </tbody> </table>	Pin #	Wire	AWG	Color	Length ℓ (mm)	1 - 4	UL1015	18	black	500	5 - 8	UL1015	18	red	500															
Pin #	Wire	AWG	Color	Length ℓ (mm)																												
1 - 4	UL1015	18	black	500																												
5 - 8	UL1015	18	red	500																												
<p>●Model number <b>H-OU-31</b> Housing : 1-1123722-6 (Tyco Electronics) Pin : 1123721-1 or 1318912-1 (Tyco Electronics) Weight : 60g max</p>	<p>●Type</p>	<p>●Wire</p> <table border="1"> <thead> <tr> <th>Pin #</th> <th>Wire</th> <th>AWG</th> <th>Color</th> <th>Length ℓ (mm)</th> </tr> </thead> <tbody> <tr> <td>1 - 6</td> <td>UL1015</td> <td>18</td> <td>red</td> <td>500</td> </tr> </tbody> </table>	Pin #	Wire	AWG	Color	Length ℓ (mm)	1 - 6	UL1015	18	red	500																				
Pin #	Wire	AWG	Color	Length ℓ (mm)																												
1 - 6	UL1015	18	red	500																												

<p>●Model number <b>H-OU-32</b> Housing : 1-1123722-7 (Tyco Electronics) Pin : 1123721-1 or 1318912-1 (Tyco Electronics) Weight : 70g max</p>	<p>●Type</p>	<p>●Wire</p> <table border="1"> <thead> <tr> <th>Pin #</th> <th>Wire</th> <th>AWG</th> <th>Color</th> <th>Length ℓ (mm)</th> </tr> </thead> <tbody> <tr> <td>1 - 7</td> <td>UL1015</td> <td>18</td> <td>black</td> <td>500</td> </tr> </tbody> </table>	Pin #	Wire	AWG	Color	Length ℓ (mm)	1 - 7	UL1015	18	black	500					
Pin #	Wire	AWG	Color	Length ℓ (mm)													
1 - 7	UL1015	18	black	500													
<p>●Model number <b>H-OU-33</b> Housing : 1-1123722-2 (Tyco Electronics) Pin : 1123721-1 or 1318912-1 (Tyco Electronics) Weight : 20g max</p>	<p>●Type</p>	<p>●Wire</p> <table border="1"> <thead> <tr> <th>Pin #</th> <th>Wire</th> <th>AWG</th> <th>Color</th> <th>Length ℓ (mm)</th> </tr> </thead> <tbody> <tr> <td>1</td> <td>UL1015</td> <td>18</td> <td>black</td> <td>500</td> </tr> <tr> <td>2</td> <td>UL1015</td> <td>18</td> <td>red</td> <td>500</td> </tr> </tbody> </table>	Pin #	Wire	AWG	Color	Length ℓ (mm)	1	UL1015	18	black	500	2	UL1015	18	red	500
Pin #	Wire	AWG	Color	Length ℓ (mm)													
1	UL1015	18	black	500													
2	UL1015	18	red	500													
<p>●Model number <b>H-OU-47</b> Housing : 1-1123722-0 (Tyco Electronics) Pin : 1123721-1 or 1318912-1 (Tyco Electronics) Weight : 100g max</p>	<p>●Type</p>	<p>●Wire</p> <table border="1"> <thead> <tr> <th>Pin #</th> <th>Wire</th> <th>AWG</th> <th>Color</th> <th>Length ℓ (mm)</th> </tr> </thead> <tbody> <tr> <td>1 - 5</td> <td>UL1015</td> <td>18</td> <td>black</td> <td>500</td> </tr> <tr> <td>6 - 10</td> <td>UL1015</td> <td>18</td> <td>red</td> <td>500</td> </tr> </tbody> </table>	Pin #	Wire	AWG	Color	Length ℓ (mm)	1 - 5	UL1015	18	black	500	6 - 10	UL1015	18	red	500
Pin #	Wire	AWG	Color	Length ℓ (mm)													
1 - 5	UL1015	18	black	500													
6 - 10	UL1015	18	red	500													

## LFP Series

Harness for connecting the external capacitor unit is prepared for LFP240/300F(U1 type).

<p>●Model number <b>H-IN-23</b> Housing : VHR-4N(J.S.T.) Pin : SVH-21T-P1.1(J.S.T.) Weight : 5g max</p>	<p>●Type</p>	<p>●Wire</p> <table border="1"> <thead> <tr> <th>Pin #</th> <th>Wire</th> <th>AWG</th> <th>Color</th> <th>Length ℓ (mm)</th> </tr> </thead> <tbody> <tr> <td>1</td> <td></td> <td></td> <td></td> <td></td> </tr> <tr> <td>2</td> <td>UL1015</td> <td>20</td> <td>black</td> <td>100</td> </tr> <tr> <td>3</td> <td></td> <td></td> <td></td> <td></td> </tr> <tr> <td>4</td> <td>UL1015</td> <td>20</td> <td>red</td> <td>100</td> </tr> </tbody> </table>	Pin #	Wire	AWG	Color	Length ℓ (mm)	1					2	UL1015	20	black	100	3					4	UL1015	20	red	100
Pin #	Wire	AWG	Color	Length ℓ (mm)																							
1																											
2	UL1015	20	black	100																							
3																											
4	UL1015	20	red	100																							

## LHA Series

Harness for connecting the external capacitor unit is prepared for LHA150F/300F(U1 type).

<p>●Model number <b>H-IN-25</b> CN A: Housing : VHR-3N (J.S.T.) Pin : SVH-21T-P1.1 (J.S.T.) CN B: Housing : VHR-4N (J.S.T.) Pin : SVH-21T-P1.1 (J.S.T.) Weight : 5g max</p>	<p>●Type</p>	<p>●Wire</p> <table border="1"> <thead> <tr> <th>Pin #</th> <th>Wire</th> <th>AWG</th> <th>Color</th> <th>Length ℓ (mm)</th> </tr> </thead> <tbody> <tr> <td rowspan="3">CN A</td> <td>1</td> <td>UL1015</td> <td>20</td> <td>black</td> <td>100</td> </tr> <tr> <td>2</td> <td></td> <td></td> <td></td> <td></td> </tr> <tr> <td>3</td> <td>UL1015</td> <td>20</td> <td>red</td> <td>100</td> </tr> <tr> <td rowspan="3">CN B</td> <td>1</td> <td></td> <td></td> <td></td> <td></td> </tr> <tr> <td>2</td> <td>UL1015</td> <td>20</td> <td>black</td> <td>100</td> </tr> <tr> <td>3</td> <td></td> <td></td> <td></td> <td></td> </tr> <tr> <td></td> <td>4</td> <td>UL1015</td> <td>20</td> <td>red</td> <td>100</td> </tr> </tbody> </table>	Pin #	Wire	AWG	Color	Length ℓ (mm)	CN A	1	UL1015	20	black	100	2					3	UL1015	20	red	100	CN B	1					2	UL1015	20	black	100	3						4	UL1015	20	red	100
Pin #	Wire	AWG	Color	Length ℓ (mm)																																									
CN A	1	UL1015	20	black	100																																								
	2																																												
	3	UL1015	20	red	100																																								
CN B	1																																												
	2	UL1015	20	black	100																																								
	3																																												
	4	UL1015	20	red	100																																								

Harness for remote ON/OFF(R type) is prepared in LDA, LEA, LEB, LEP, LFA, LFP & LMA series.

LDA Series  
 LEA Series  
 LEB Series  
 LEP Series  
 LFA Series  
 LHA Series  
 LFP Series  
 LMA Series

Mating harness

Model	Harness model #
LDA50F, LDA75F, LDA100W, LDA150W, LDA300W	H-RC-1
LEA50F, LEA75F, LEA100F, LEA150F, LEP100F, LEP150F, LEP240F	
LEB100F, LEB150F, LEB225F	
LFA100F, LFA150F, LFA240F, LFA300F, LFP100F, LFP150F, LFP240F, LFP300F	
LHA100F, LHA150F, LHA300F	
LMA100F, LMA150F, LMA240F	

<p>●Model number</p> <p><b>H-RC-1</b></p> <p>Housing : XHP-2 (J.S.T.)                  Pin : SXH-001T-P0.6 (J.S.T.)                  Weight : 7g max</p>	<p>●Type</p>	<p>●Wire</p> <table border="1"> <thead> <tr> <th>Pin #</th> <th>Wire</th> <th>AWG</th> <th>Color</th> <th>Length l (mm)</th> </tr> </thead> <tbody> <tr> <td>1</td> <td>UL1007</td> <td>22</td> <td>orange</td> <td>500</td> </tr> <tr> <td>2</td> <td>UL1007</td> <td>22</td> <td>blue</td> <td>500</td> </tr> </tbody> </table>	Pin #	Wire	AWG	Color	Length l (mm)	1	UL1007	22	orange	500	2	UL1007	22	blue	500
Pin #	Wire	AWG	Color	Length l (mm)													
1	UL1007	22	orange	500													
2	UL1007	22	blue	500													

## External capacitor unit

By connecting an external capacitor unit to the power supply, it is possible to extend the hold-up time.

External capacitor unit model	Approved power supply	Hold-up time *	Appearance
<b>CR-HUT241-1</b> (Rated capacitance:240 $\mu$ F)	LHA150F LHA300F LFP240F LFP300F RBC200F <U1 type>	100 ms (Power supply output 180W)	
		55 ms (Power supply output 360W)	
<b>CR-HUT721-1</b> (Rated capacitance:720 $\mu$ F)		220 ms (Power supply output 180W)	
		110 ms (Power supply output 360W)	
<b>CR-HUT282-2</b> (Rated capacitance:2,800 $\mu$ F)		650 ms (Power supply output 180W)	
		300 ms (Power supply output 360W)	
<b>CR-HUT502-2</b> (Rated capacitance:5,040 $\mu$ F)	1,100 ms (Power supply output 180W)		
	500 ms (Power supply output 360W)		

\* It is reference data in the case of connecting LFP300F-□-TU1Y.  
 Hold-up time will vary depending on the environment (power supply, output power, etc).  
 Please refer to the Instruction Manual of approved power supply for more information.

## 1 Specification

	ITEM	CR-HUT241-1	CR-HUT721-1	CR-HUT282-2	CR-HUT502-2
ELECTRICAL SPECIFICATIONS	INPUT VOLTAGE[V]	DC420max			
	RATED CAPACITANCE [ $\mu$ F]	240typ	720typ	2,800typ	5,040typ
	CHARGE COMPLETION TIME [s] *1	2yp	5yp	30typ	60typ
	LED LIGHTING VOLTAGE [V] *2	45typ			
	DISCHARGING TIME [s]	30typ	55typ	165typ	285typ
ENVIRONMENT	OPERATING TEMP., HUMID. *3	-20 to +70°C, 20 - 90%RH (Non condensing)			
	STORAGE TEMP., HUMID.	-20 to +75°C, 20 - 90%RH (Non condensing)			
	VIBRATION	10 - 55Hz, 19.6m/s <sup>2</sup> (2G), 3minutes period, 60minutes each along X, Y and Z axis			
	IMPACT	196.1m/s <sup>2</sup> (20G), 11ms, once each X, Y and Z axis			
AGENCY APPROVALS		Be certified by connecting to the correct power			
OTHERS	SIZE	45 × 48 × 110mm [1.77 × 1.89 × 4.33 inches] (W × H × D)		85 × 58 × 206mm [3.35 × 2.28 × 8.11 inches] (W × H × D)	
	WEIGHT	105g max	195g max	525g max	860g max
	COOLING METHOD	Convection			

\*1 Time to be charged to over 98% of the applied voltage.

\*2 Capacitor voltage which LED turns on.

\*3 LED turn off time after input voltage shut off from full charged condition.

## 2 External View

### 1. CR-HUT□-1

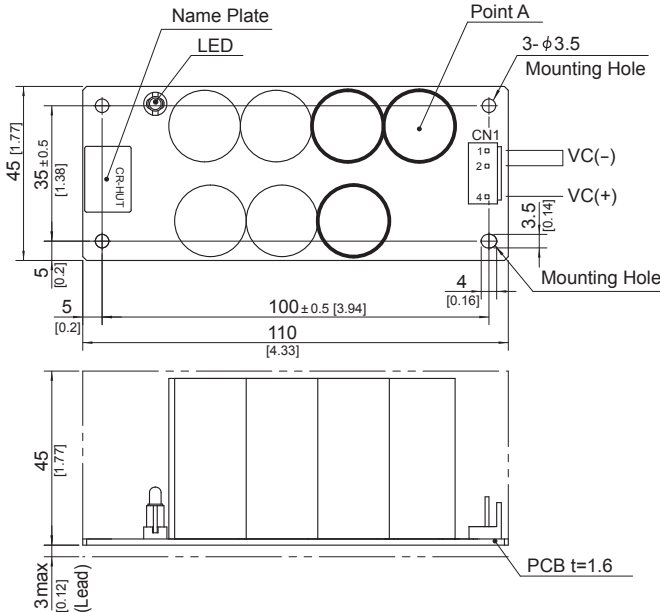

- ※4 Mounting holes are existing.
- ※The back side of P.C.B. of the power supply is assembled some SMDs.  
Be attention not to bump against the attached area by vibration.
- ※Do not use press-fitting bush.
- ※Point A is thermometry points. Please refer to Instruction Manual 3.

- ※Dimensions in mm, [ ]=inches
- ※Tolerance :  $\pm 1$  [ $\pm 0.04$ ]
- ※Weight : 105g max (CR-HUT241-1)  
195g max (CR-HUT721-1)
- ※PCB material : CEM3
- ※Thick line represents the capacitor mounted on CR-HUT241-1.  
All capacitors are mounted on CR-HUT721-1.

#### CN1

Connector	B3P4-VH			
Mating Connector	VHR-4N			
Terminal	Chain : SVH-21T-P1.1			
	Loose : BVH-21T-P1.1			
Manufacturer	J.S.T.			
Pin No.	1	2	3	4
Function	VC(-)	VC(-)		VC(+)

※Pin 3 is removed

### 2. CR-HUT□-2

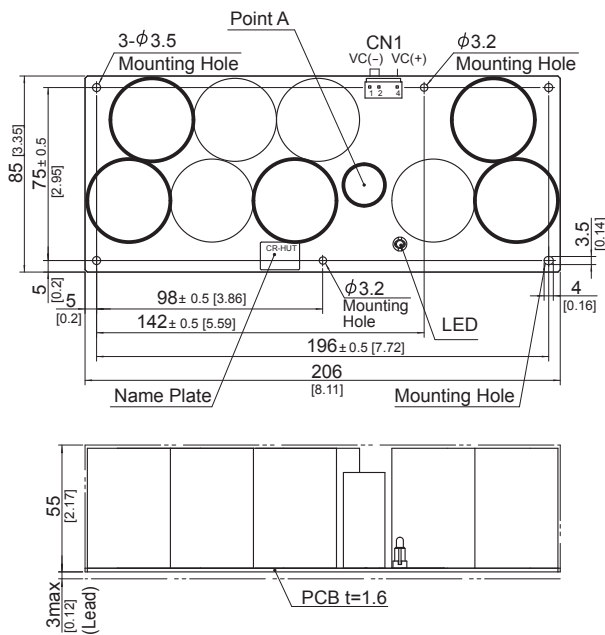

- ※4 Mounting holes are existing.
- ※The back side of P.C.B. of the power supply is assembled some SMDs.  
Be attention not to bump against the attached area by vibration.
- ※Do not use press-fitting bush.
- ※Point A is thermometry points. Please refer to Instruction Manual 3.

- ※Dimensions in mm, [ ]=inches
- ※Tolerance :  $\pm 1$  [ $\pm 0.04$ ]
- ※Weight : 525g max (CR-HUT282-2)  
860g max (CR-HUT502-2)
- ※PCB material : CEM3
- ※Thick line represents the capacitor mounted on CR-HUT282-2.  
All capacitors are mounted on CR-HUT502-2.

#### CN1

Connector	B3P4-VH			
Mating Connector	VHR-4N			
Terminal	Chain : SVH-21T-P1.1			
	Loose : BVH-21T-P1.1			
Manufacturer	J.S.T.			
Pin No.	1	2	3	4
Function	VC(-)	VC(-)		VC(+)

※Pin 3 is removed

# 3 Assembling and Installation Method

## 3.1 Installation method

- This external capacitor unit is manufactured by SMD technology. The stress to P.C.B like twisting or bending causes the defect of the unit, so handle the unit with care.
- In case of metal chassis, keep the distance between  $d_1$  &  $d_2$  for to insulate between lead of component and metal chassis. If it is less than  $d_1$  &  $d_2$ , insert the insulation sheet between external capacitor unit and metal chassis.

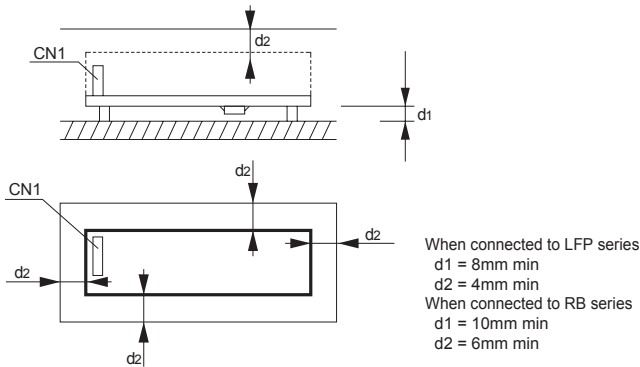

Fig.3.1 Installation method

- There is a possibility that it is not possible to cool enough when the external capacitor unit is used by the sealing up space as showing in Figure 3.2. Please use it after confirming the temperature of point A of Instruction Manual 3.2.

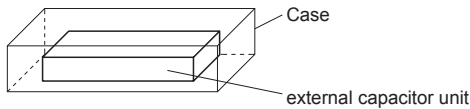

Fig.3.2 Installation example

### ■ Connection method

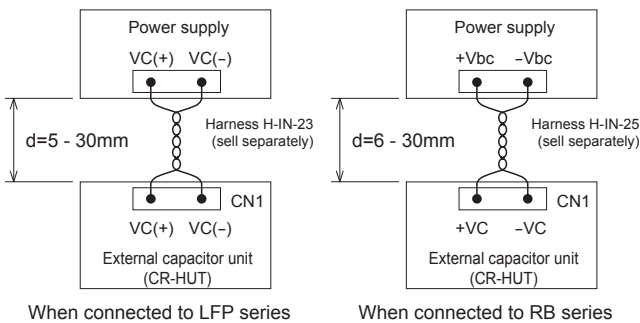

Fig.3.3 Connection method

### ● Caution

- (1) Distance between the external capacitor unit and power supply unit must be secured more than 5mm. When connected to RB series, distance must be secured more than 6mm.
- (2) It must be 30mm or less, since the noise is generated from the wire which is connecting the external capacitor unit and power supply. And, it is necessary to twist the wire as short as possible.
- (3) It is necessary to use wires which rated voltage is 600V or more.

### ■ Mounting method

#### ● CR-HUT□-1

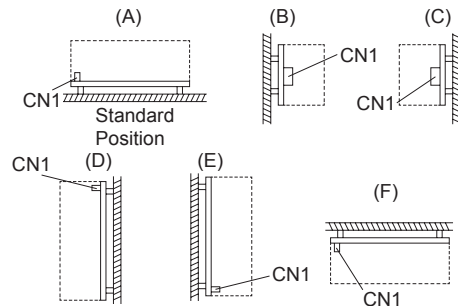

Fig.3.4 CR-HUT□-1 Mounting method

#### ● CR-HUT□-2

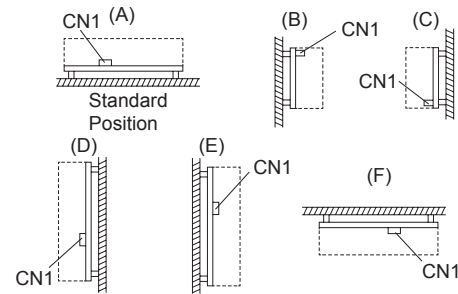

Fig.3.5 CR-HUT□-2 Mounting method

## 3.2 Environment to use the Unit and Installation environment

- When using the unit, it is necessary to dissipate heat of the external capacitor unit. Table 3.1 shows the relation between the maximum temperature Point A and Installation environment. Please consider the ventilation to keep sufficient convection for whole external capacitor unit. And temperature of Point A must be kept under maximum temperature shown table 3.1. The expectancy life at maximum temperature of Point A is three years or more. Please refer to External View for the position of Point A. Please contact us for details.

### Remarks:

- \* Please be careful of electric shock or earth leakage in case of temperature measurement, because Point A is live potential.
- \* Please refer to 3.4 if you want to extend the longevity of the expectancy life.



Table 3.1 Temperatures of Point A

Mounting Method	Cooling Method	Max temperature[°C]
A,B,C,D,E	Convection	86
F	Convection	81
A,B,C,D,E,F	Forced air	75

### 3.3 Mounting screw

■The mounting screw should be M3. The hatched area shows the allowance of metal parts for mounting.

#### ● CR-HUT□-1

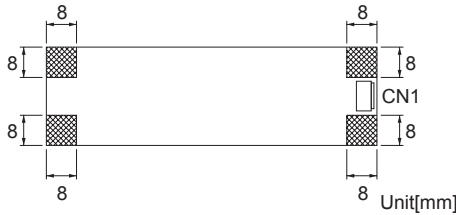

Fig.3.6 CR-HUT□-1 Allowance of metal for mounting

#### ● CR-HUT□-2

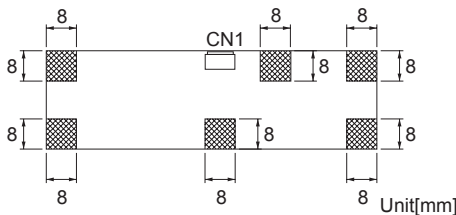

Fig.3.7 CR-HUT□-2 Allowance of metal for mounting

### 3.4 Expectancy life and warranty

■Expectancy Life.

Mounting Method	Cooling Method	Average ambient temperature (year)	Expectancy Life
A,B,C,D,E,F	Convection	Ta = 60°C or less	10years
		Ta = 70°C	6years

■Warranty

Warranty 5 years.

## 4 Others

- This external capacitor unit is the rugged PCB type. Do not drop conductive objects in the external capacitor unit.
- Do not touch absolutely during operation.
  - There is a risk of electric shock.
- High voltage remains inside the external capacitor unit after voltage shut off.
  - There is a risk of electric shock, do not touch until the LED turns off.
- There is possibility that electric charge is remained inside the capacitor.
  - Do not short-circuit the CN1 terminals.
- This external capacitor unit is manufactured by SMD technology.
  - The stress to PCB like twisting or bending causes the defect of the unit, so handle the unit with care.

- Tighten all the screws in the screw hole.
  - CR-HUT□-1 (4 places)
  - CR-HUT□-2 (6 places)

CR-HUT-2 may be a mounting method of the following. (Refer Fig.4.1)

Screw should be used to hole A (4 places).  
 Screw or resin spacer should be used to hole B (2 places).  
 Recommendation resin spacer: MPS series (KITAGAWA INDUSTRIES CO.,LTD.)

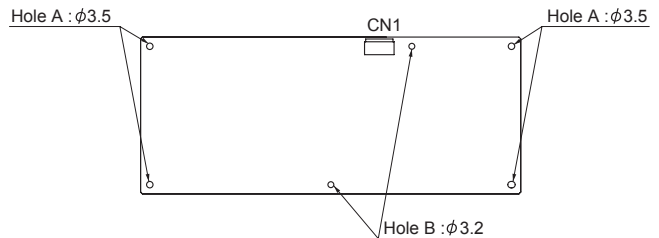

Fig.4.1 CR-HUT□-2 Resin spacer mounting method

- Install the PCB of the external capacitor unit horizontally to the surface of mounting.
- Avoid the impact such as drops.