

Applications Manual for MG40/MG80



MG40/MG80 series

	Page
1. Ordering information	MG1-1
2. Pin configuration / External view	MG2-1
2.1 Pin configuration / External view	MG2-1
3. Connection method for standard use	MG3-1
3.1 Connection for standard use	MG3-1
3.2 Wiring input pin	MG3-3
3.3 Wiring output pin	MG3-3
4. Derating	MG4-1
4.1 Input voltage - Output current Derating	MG4-1
4.2 Case temperature - Output current Derating	MG4-2
4.3 Ambient temperature - Output current Derating 【Reference】	MG4-2
5. Remote ON/OFF	MG5-1
5.1 RC response time	MG5-1
5.2 RC-OFF standby power	MG5-2
5.3 RC pin outflow current	MG5-3
6. Board layout	MG6-1
6.1 Measurement board layout	MG6-1

For MG40/MG80 series _____

1. Ordering information

<u>MGF</u>	<u>S</u>	<u>80</u>	<u>24</u>	<u>05</u>	<u>-□</u>
①	②	③	④	⑤	⑥

① Series name

MGF : MGF Series

② Output specification

S : Single output

W : Dual output

③ Output wattage

40 : 40W type

80 : 80W type

④ Input voltage

05 : DC 4.5 ~ 13 V

24 : DC 9 ~ 36 V

48 : DC 18 ~ 76 V

⑤ Output voltage

MGFS

3R3 : +3.3V

05 : +5V

12 : +12V

15 : +15V

MGFW

12 : ±12V(+24V)

15 : ±15V(+30V)

⑥ Option

-G : Capacitor between Input and Output is removed

-R : Reverses the logic of remote control function (Positive)

2. Pin configuration / External view

2.1 Pin configuration / External view

Fig.2.1.1
Pin connection
for MGFS40
/ MGFW40
(bottom view)

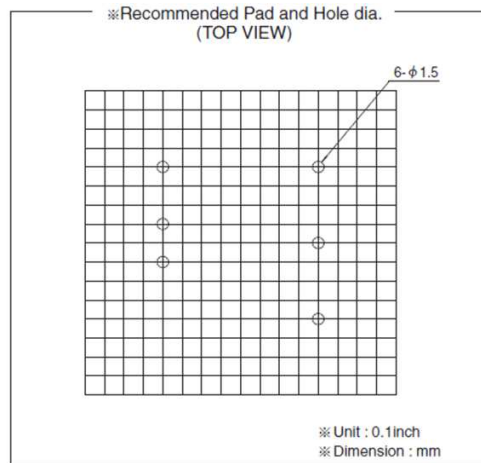
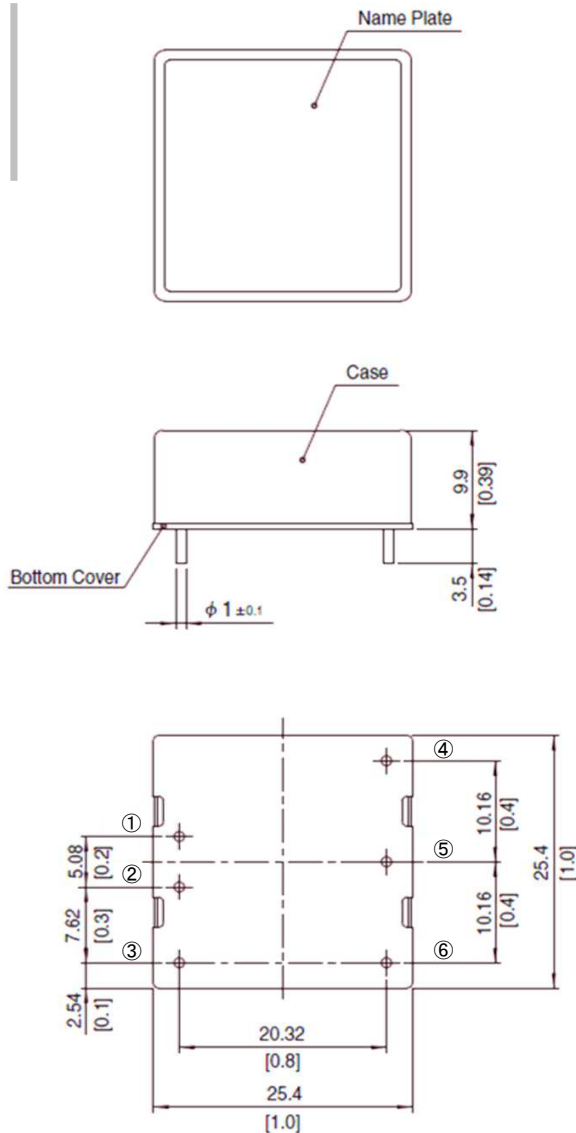

- ※ Tolerance ± 0.5 [± 0.02]
- ※ Dimensions in mm, []=inches
- ※ Pin terminal material : Copper
- ※ Plating treatment of terminal : Lead free plating
- ※ Case material : Brass
- ※ Plating treatment of case : Nickel plating
- ※ Bottom Cover : FR4 (t=0.6) [t=0.024]
- ※ Please keep enough creepage distance with the pattern on PCB and other components.
- ※ Weight 30g max

Table 2.1.1
Pin connection and
function of MGFS40
/ MGFW40

Pin No.	Pin Name	Function
①	+Vin	+DC Input
②	-Vin	-DC Input
③	RC	Remote ON/OFF
④	+Vout	+DC Output
⑤	TRM	Output Voltage Adjustment (for Single Output)
	COM	GND of Output Voltage (for Dual Output)
⑥	-Vout	-DC Output

For MG40/MG80 series

Fig.2.1.2
Pin connection
for MGFS80
/ MGFW80
(bottom view)

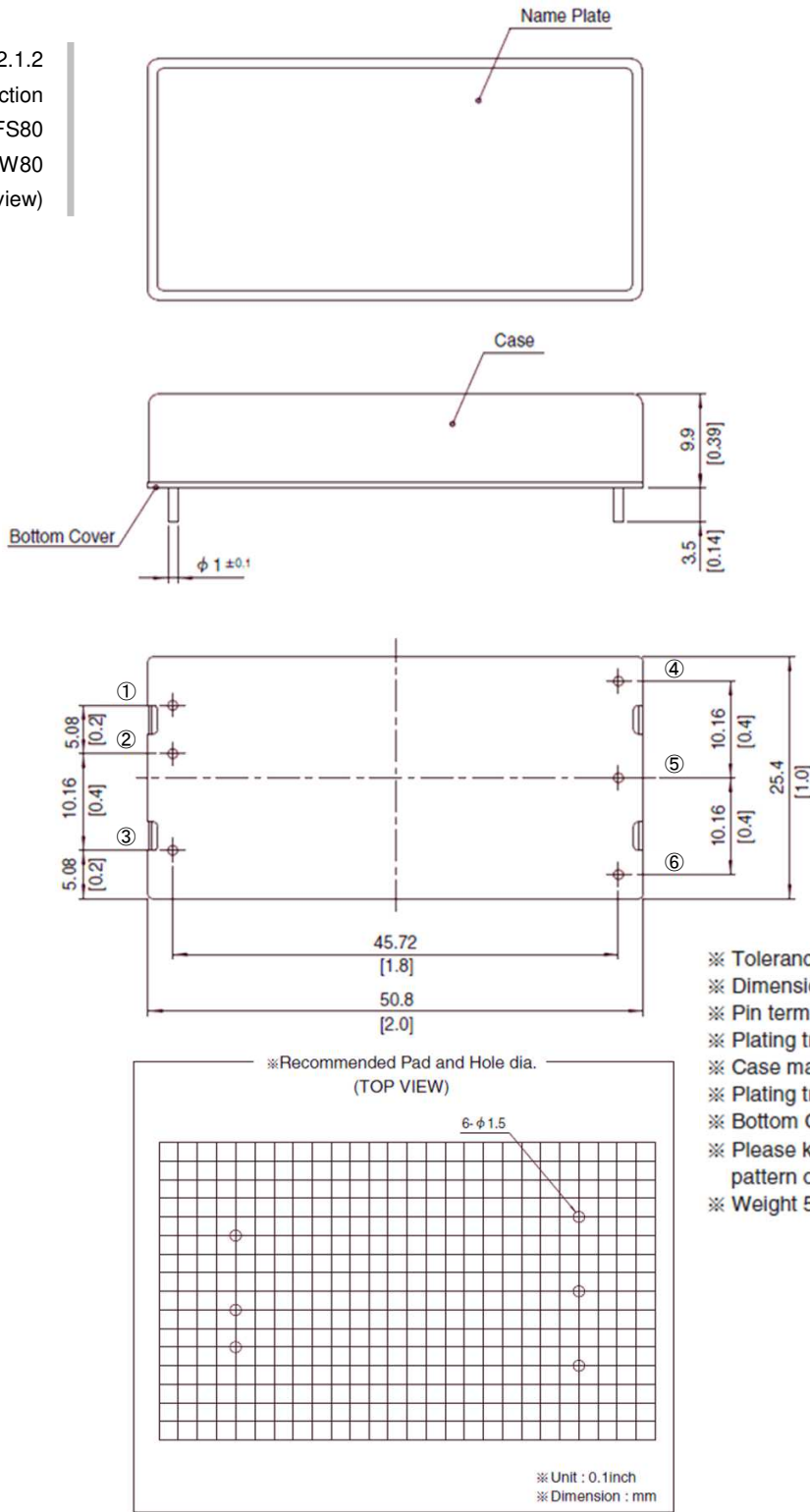

- ※ Tolerance ± 0.5 [± 0.02]
- ※ Dimensions in mm, []=inches
- ※ Pin terminal material : Copper
- ※ Plating treatment of terminal : Lead free plating
- ※ Case material : Brass
- ※ Plating treatment of case : Nickel plating
- ※ Bottom Cover : FR4 (t=0.6) [t=0.024]
- ※ Please keep enough creepage distance with the pattern on PCB and other components.
- ※ Weight 50g max

Table 2.1.2
Pin connection and
function of MGFS80
/ MGFW80

Pin No.	Pin Name	Function
①	+Vin	+DC Input
②	-Vin	-DC Input
③	RC	Remote ON/OFF
④	+Vout	+DC Output
⑤	-Vout	-DC Output (for Single Output)
	COM	GND of Output Voltage (for Dual Output)
⑥	TRM	Output Voltage Adjustment (for Single Output)
	-Vout	-DC Output (for Dual Output)

3. Connection method for standard use

3.1 Connection for standard use

Fig.3.1.1
Recommended
circuit of connect
for MGFS40
/ MGFS80

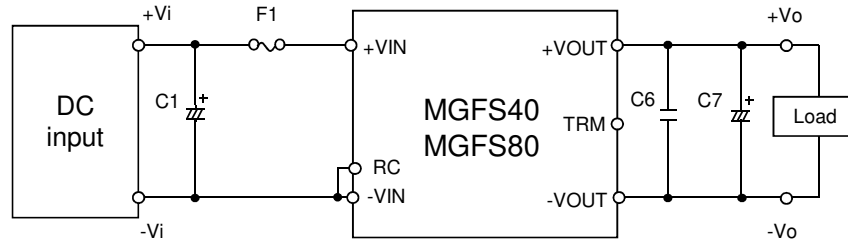

Table 3.1.1
Parts name
for MGFS40

No.	Symbol	MGFS40		
		Division	Rating	Part name
1	F1	5Vinput	15A	KMS150
		24Vinput	10A	KMS100
		48Vinput	5A	KMS50
2	C1	5Vinput	35V 220 μ F	ELXZ350E□□221MH15D
		24Vinput	63V 100 μ F	ELXZ630E□□101MH15D
		48Vinput	100V 47 μ F	EKXG201E□□470MK20S
3	C6	ALL	25V 22 μ F	GRM32ER71E226K
4	C7	3.3Voutput	25V 470 μ F	PCR1E471MCL1GS
		5Voutput	25V 470 μ F	PCR1E471MCL1GS
		12Voutput	35V 150 μ F	PCR1V151MCL1GS
		15Voutput	63V 100 μ F	PCR1J101MCL1GS

※or equivalent

Table 3.1.2
Parts name
for MGFS80

No.	Symbol	MGFS80		
		Division	Rating	Part name
1	F1	24Vinput	15A	KMS150
		48Vinput	10A	KMS100
2	C1	24Vinput	63V 100 μ F	ELXZ630E□□101MH15D
		48Vinput	100V 47 μ F	EKXG201E□□470MK20S
3	C6	ALL	25V 22 μ F	GRM32ER71E226K
4	C7	3.3Voutput	25V 470 μ F	PCR1E471MCL1GS
		5Voutput	25V 470 μ F	PCR1E471MCL1GS
		12Voutput	35V 150 μ F	PCR1V151MCL1GS
		15Voutput	63V 100 μ F	PCR1J101MCL1GS

※or equivalent

For MG40/MG80 series

Fig.3.1.2
Recommended
circuit of connect
for MGFW40
/ MGFW80

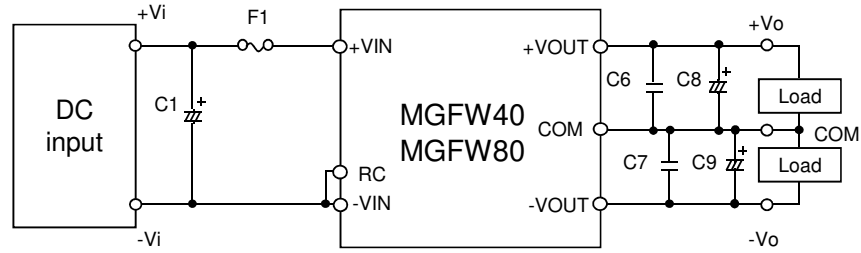

Table 3.1.3
Parts name
for MGFW40

No.	Symbol	MGFW40		
		Division	Rating	Part name
1	F1	5Vinput	15A	KMS150
		24Vinput	10A	KMS100
		48Vinput	5A	KMS50
2	C1	5Vinput	35V 220 μ F	ELXZ350E□□221MH15D
		24Vinput	63V 100 μ F	ELXZ630E□□101MH15D
		48Vinput	100V 47 μ F	EKXG201E□□470MK20S
3	C6 , C7	ALL	25V 22 μ F	GRM32ER71E226K
4	C8 , C9	\pm 12Voutput	63V 100 μ F	PCR1J101MCL1GS
		\pm 15Voutput	80V 47 μ F	PCR1K470MCL1GS

※or equivalent

Table 3.1.4
Parts name
for MGFW80

No.	Symbol	MGFW80		
		Division	Rating	Part name
1	F1	24Vinput	15A	KMS150
		48Vinput	10A	KMS100
2	C1	24Vinput	63V 100 μ F	ELXZ630E□□101MH15D
		48Vinput	100V 47 μ F	EKXG201E□□470MK20S
3	C6 , C7	ALL	25V 22 μ F	GRM32ER71E226K
4	C8 , C9	\pm 12Voutput	63V 100 μ F	PCR1J101MCL1GS
		\pm 15Voutput	80V 47 μ F	PCR1K470MCL1GS

※or equivalent

For MG40/MG80 series

3.2 Wiring input pin

(1) External fuse :F1

- Fuse is not built-in on input side. In order to protect the unit, install the normal-brow type fuse on + Vin of the input side.
- When the input voltage from a front end unit is supplied to multiple unit, install the normal-brow type fuse on input side of the each unit.

Table 3.2.1
Recommend
fuse

Model Input Voltage	MGFS40 MGFW40	MGFS80 MGFW80
5V	15A	
24V	10A	15A
48V	5A	10A

3.3 Wiring output pin

(1) External capacitor on the output side : Co (MGFS40 / MGFS80...C7, MGFW40 / MGFW80...C8,C9)

- In order to reduce output ripple noise, connect the capacitor Co to the output side.
- Table 3.3.1 shows the recommended external capacitor and maximum external capacitor on the output side.
- When electrolytic capacitors are used, the capacitance decreases at low temperature, so -20 °C or less recommend twice the Recommend Co of Table 3.3.1.

Table 3.3.1
Recommend external
capacitor and
maximum external
capacitor on the
output side : Co

Model Output Voltage	MGFS40 / MGFW40		MGFS80 / MGFW80	
	Recommended Co	Maximum Co	Recommended Co	Maximum Co
3.3V	470 μ F	20,000 μ F	470 μ F	20,000 μ F
5V	470 μ F	14,700 μ F	470 μ F	14,700 μ F
12V	150 μ F	2,200 μ F	150 μ F	2,200 μ F
15V	100 μ F	2,200 μ F	100 μ F	2,200 μ F
\pm 12V	100 μ F	1,000 μ F	100 μ F	1,000 μ F
\pm 15V	47 μ F	1,000 μ F	47 μ F	1,000 μ F

4. Derating

- Please use it below the input voltage derating value of section 4.1.
- Make sure that the temperature at point A in section 4.2 is less than or equal to the derating value.
Also, make sure that the ambient temperature of the power supply does not exceed 85 °C.
- If both Section 4.1 and Section 4.2 are required, apply the lower derating value.

4.1 Input voltage - Output current Derating

Fig.4.1.1
Input voltage
Derating for
MGF□4005□

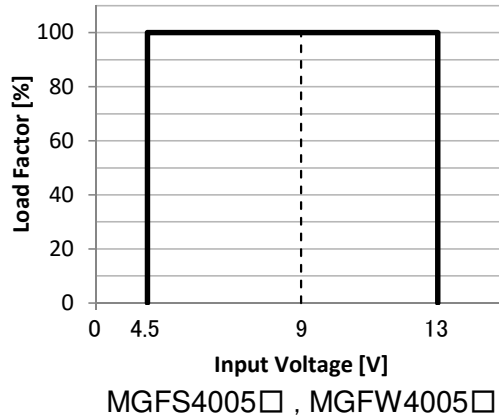

Fig.4.1.2
Input voltage
Derating for
MGF□4024□
/ MGF□8024□

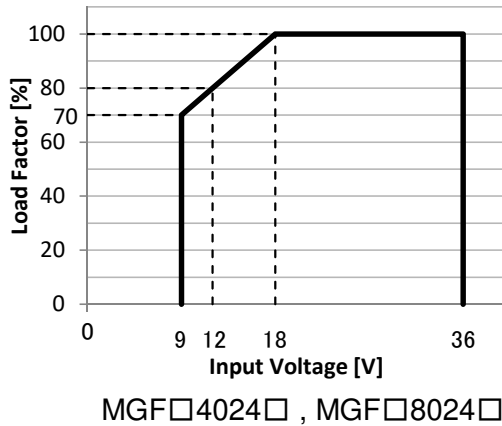
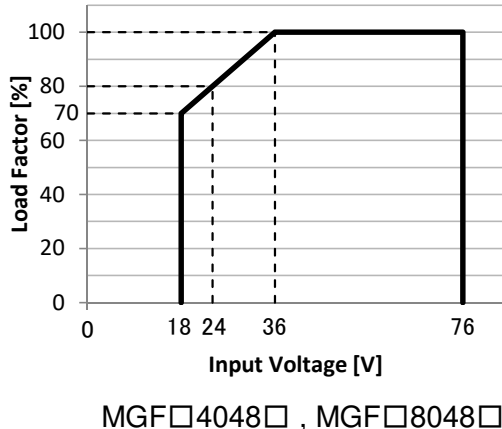

Fig.4.1.3
Input voltage
Derating for
MGF□4048□
/ MGF□8048□



4.2 Case temperature - Output current Derating

Fig.4.2.1
Case temperature
Derating for MGFS40
/ MGFW40

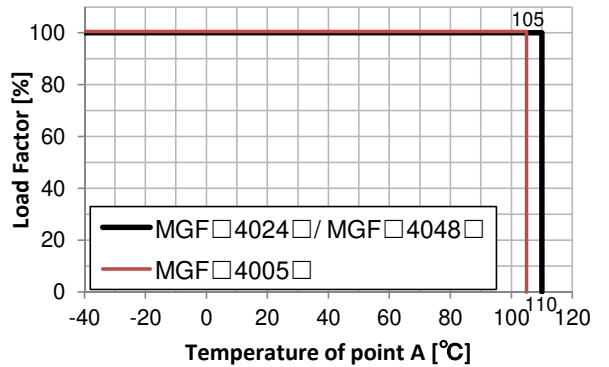
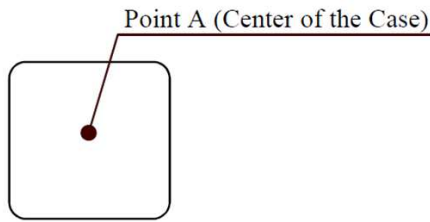
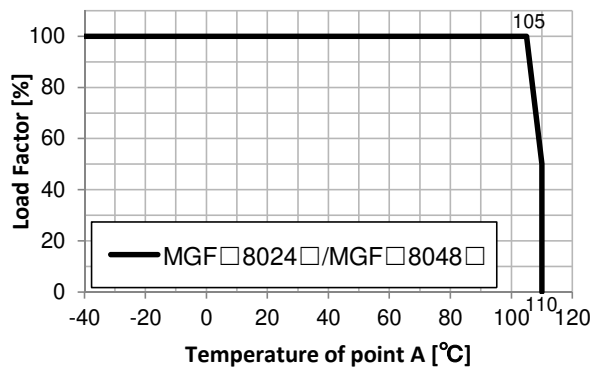
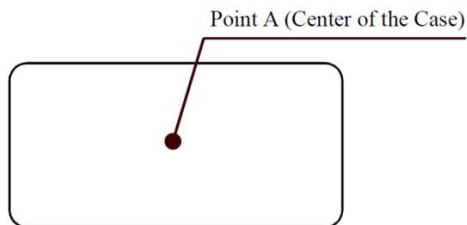

Fig.4.2.2
Case temperature
Derating for MGFS80
/ MGFW80



4.3 Ambient temperature - Output current Derating 【Reference】

- Indicates ambient temperature derating under our temperature measurement environment.
It depends on the installation environment, so please refer to it.
Please confirm the case top surface point A temperature with a real machine.

Fig.4.3.1
Installation
method

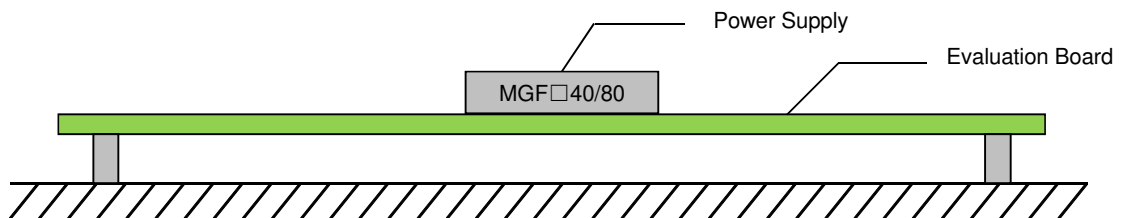

Evaluation board information

Size 220 mm x 90 mm , Board thickness t = 1.6 mm
FR-4 (double-sided board)
Copper foil thickness: 70 μm

For MG40/MG80 series

Fig.4.3.2
Derating of
MGFS4005□

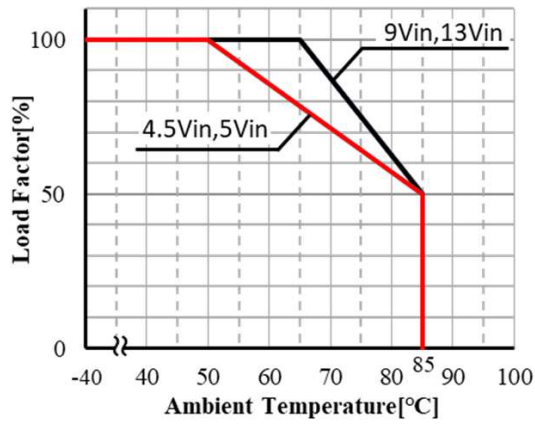

(1) MGFS40053R3

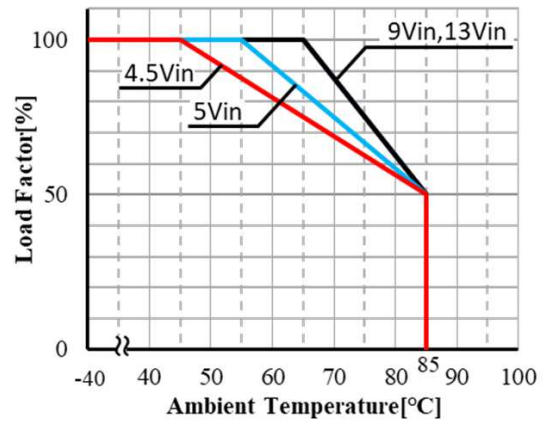

(2) MGFS400505

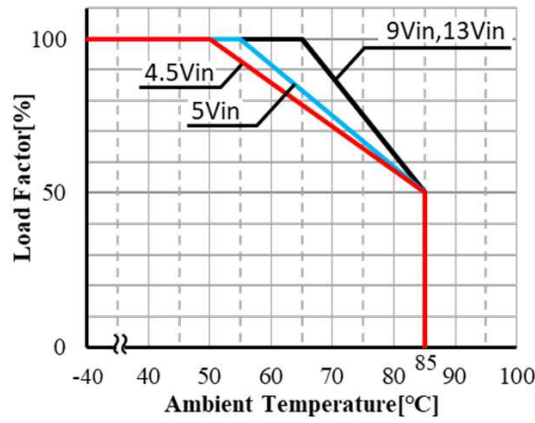

(3) MGFS400512

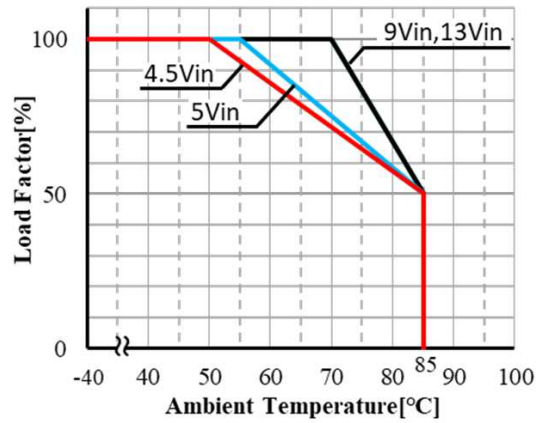

(4) MGFS400515

Fig.4.3.3
Derating of
MGFW4005□

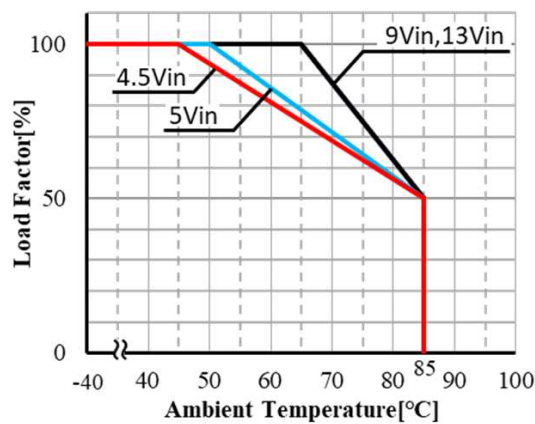

(1) MGFW400512

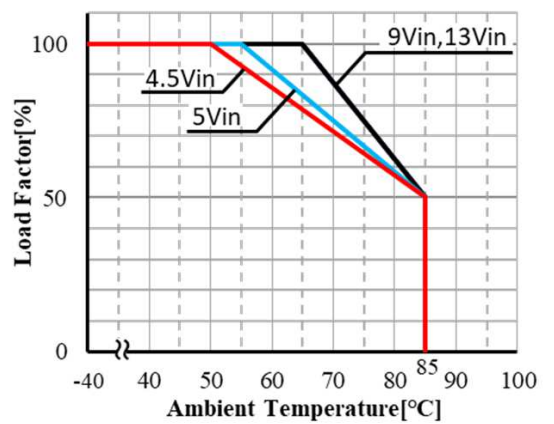

(2) MGFW400515

For MG40/MG80 series

Fig.4.3.4
Derating of
MGFS4024□

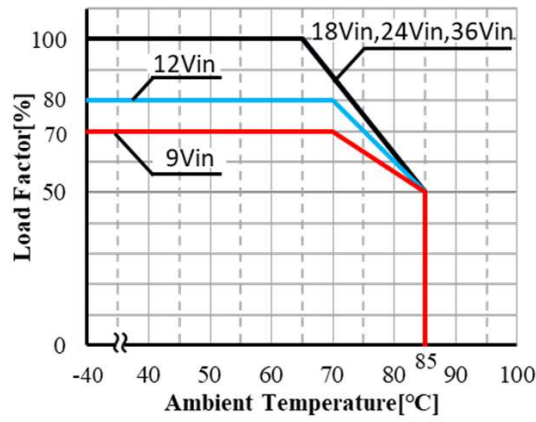

(1) MGFS40243R3

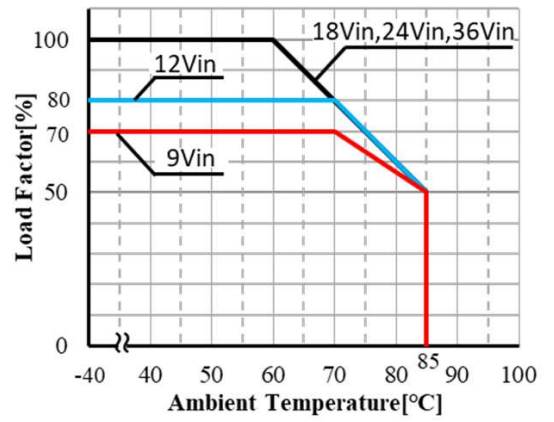

(2) MGFS402405

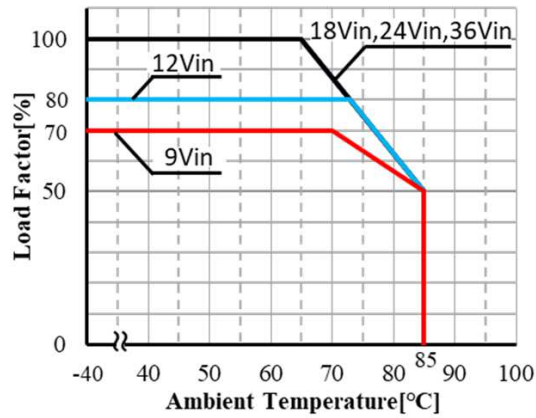

(3) MGFS402412

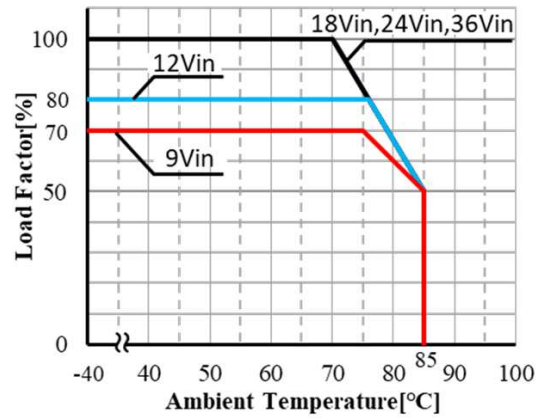

(4) MGFS402415

Fig.4.3.5
Derating of
MGFW4024□

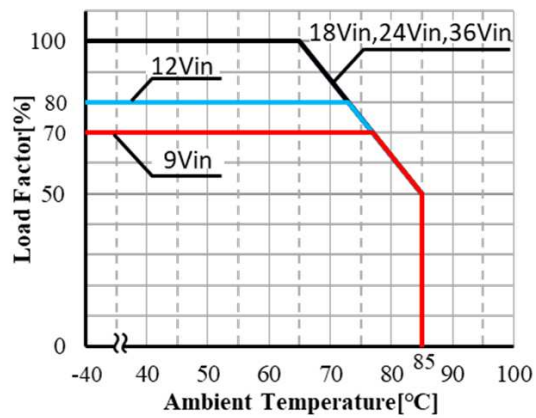

(1) MGFW402412

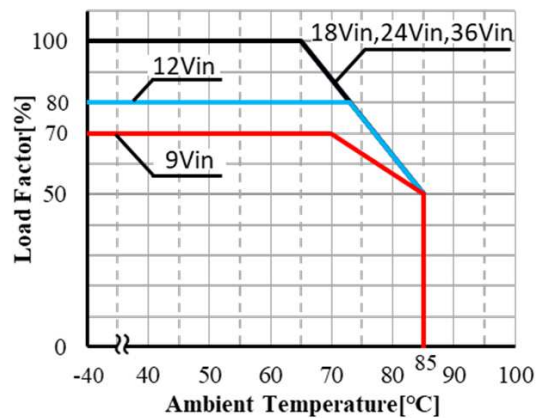

(2) MGFW402415

For MG40/MG80 series

Fig.4.3.6
Derating of
MGFS4048□

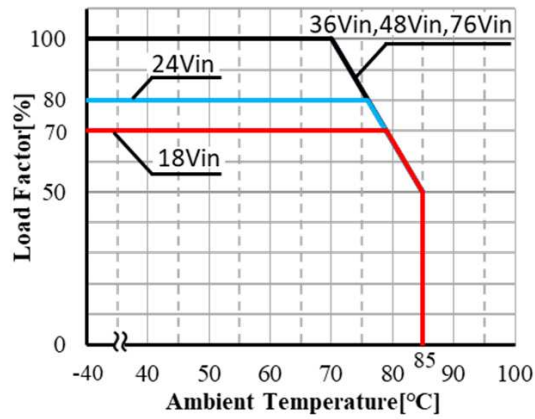

(1) MGFS40483R3

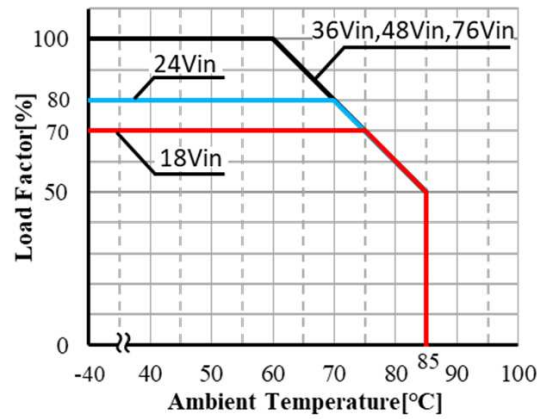

(2) MGFS404805

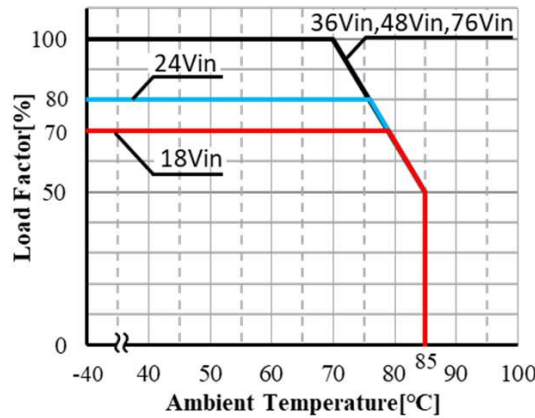

(3) MGFS404812

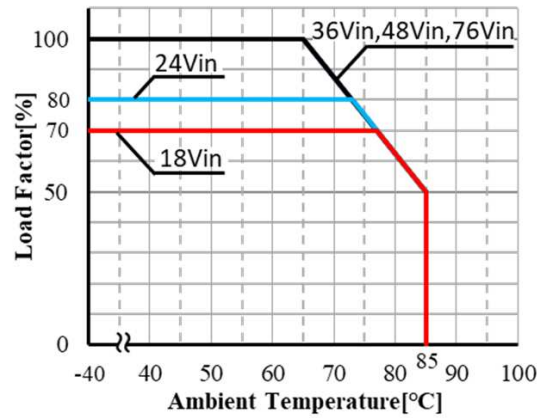

(4) MGFS404815

Fig.4.3.7
Derating of
MGFW4024□

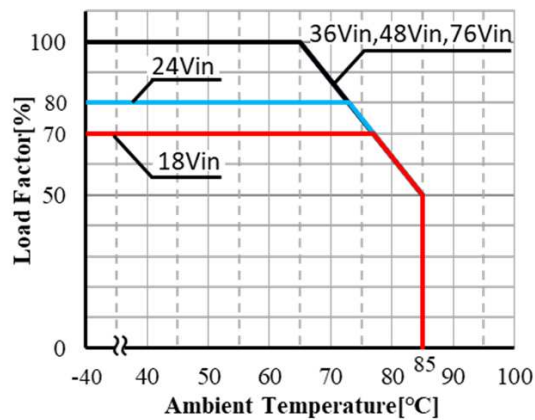

(1) MGFW404812

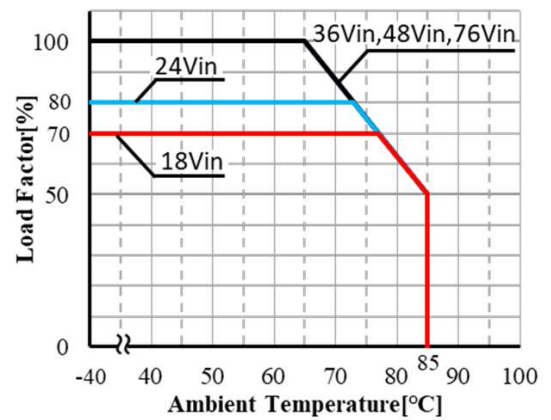

(2) MGFW404815

For MG40/MG80 series

Fig.4.3.8
Derating of
MGFS8024□

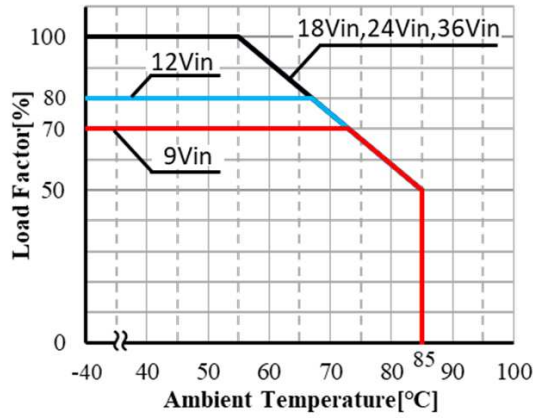

(1) MGFS80243R3

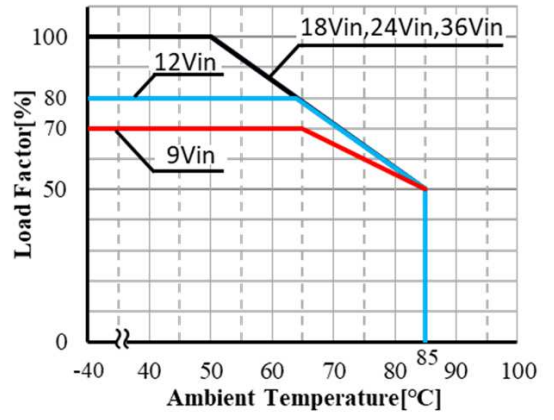

(2) MGFS802405

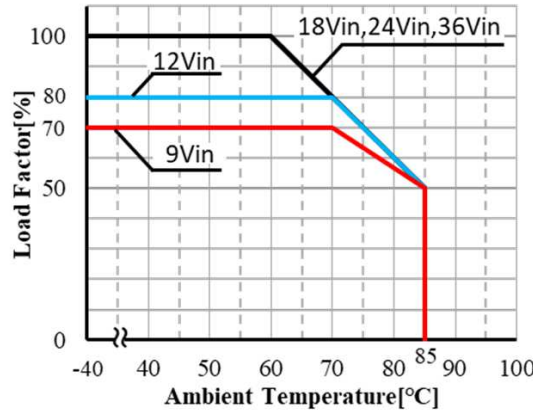

(3) MGFS802412

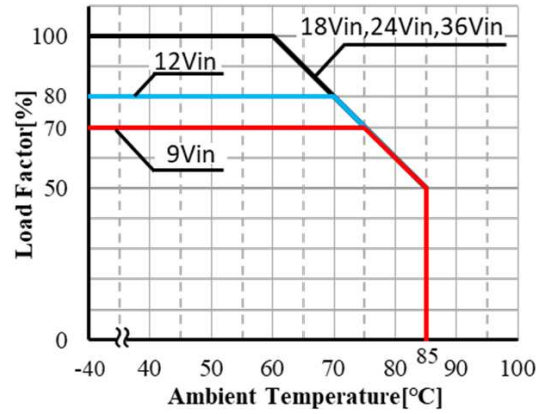

(4) MGFS802415

Fig.4.3.9
Derating of
MGFW8024□

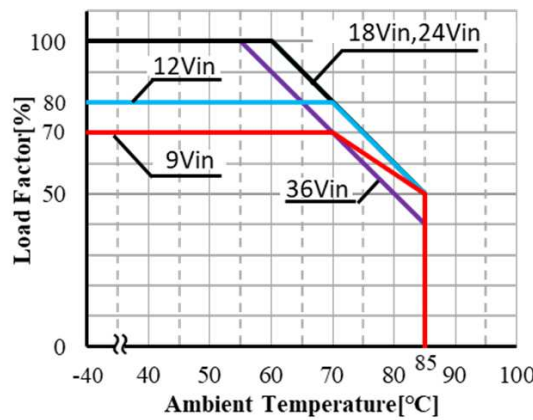

(1) MGFW802412

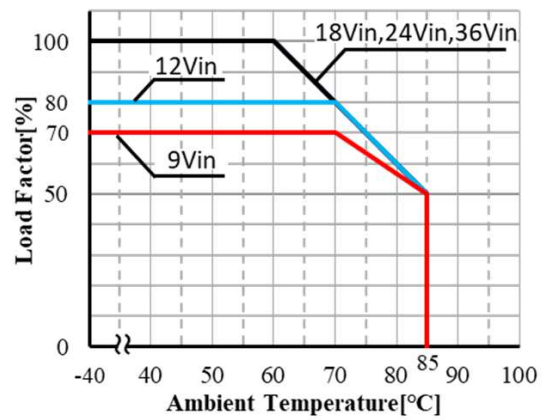

(2) MGFW802415

For MG40/MG80 series

Fig.4.3.10
Derating of
MGFS8048□

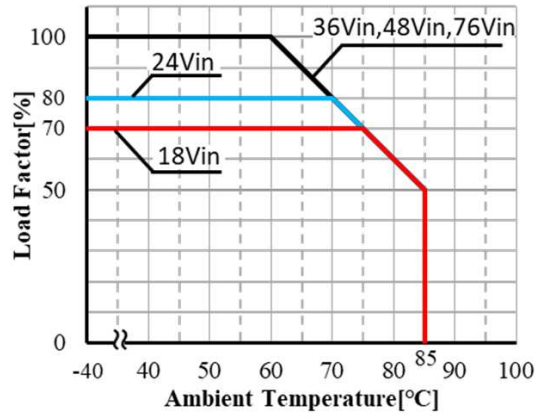

(1) MGFS80483R3

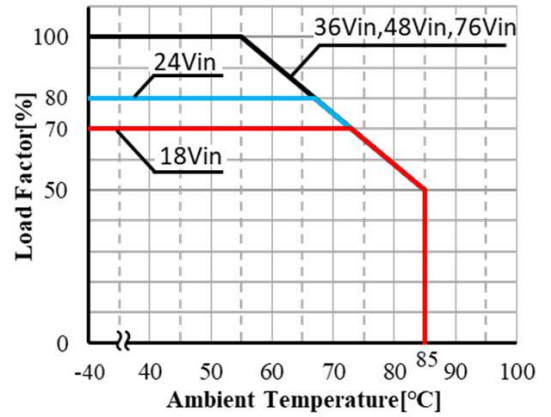

(2) MGFS804805

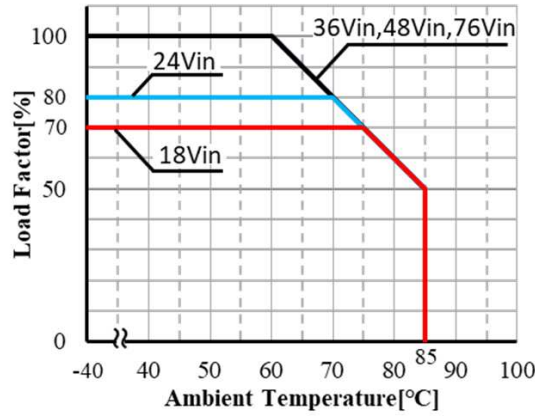

(3) MGFS804812

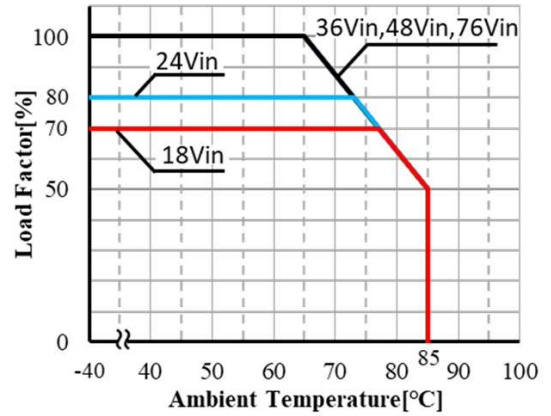

(4) MGFS804815

Fig.4.3.11
Derating of
MGFW8048□

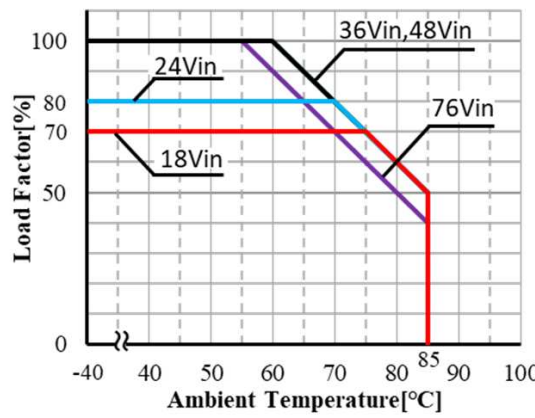

(1) MGFW804812

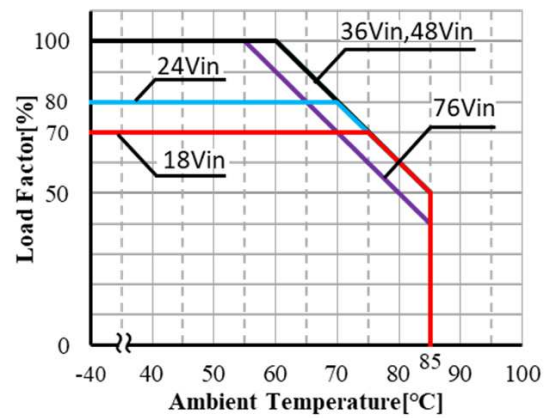

(2) MGFW804815

5. Remote ON/OFF

5.1 RC response time

Fig.5.1.1
Measurement circuit

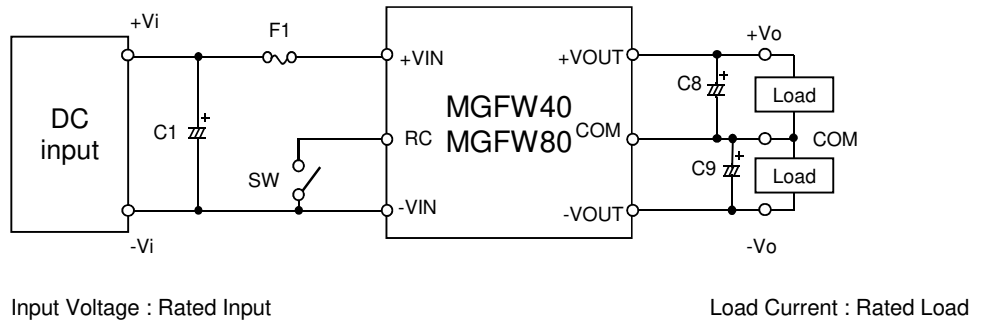
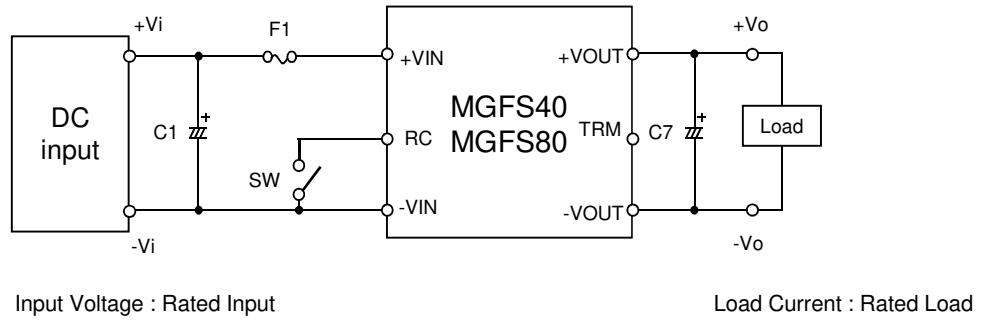
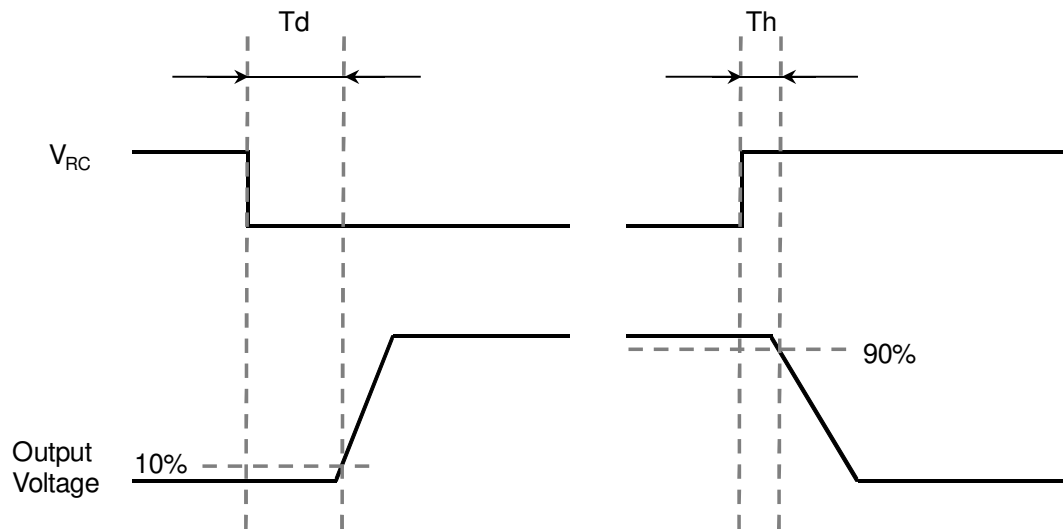

Fig.5.1.2
RC response time
for MGFS40
/ MGF40
/ MGFS80
/ MGF80
※Reference data



MGF□40	
Td	Th
2.5 ms	0.13 ms

Refer to the technical data for rise time and fall time.

MGF□80	
Td	Th
2.5 ms	0.13 ms

Refer to the technical data for rise time and fall time.

5.2 RC-OFF standby power

Fig.5.2.1
RC-OFF standby power
for MGFS40
/ MGFW40

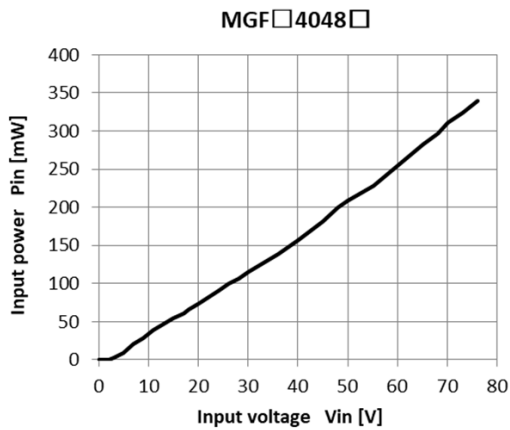
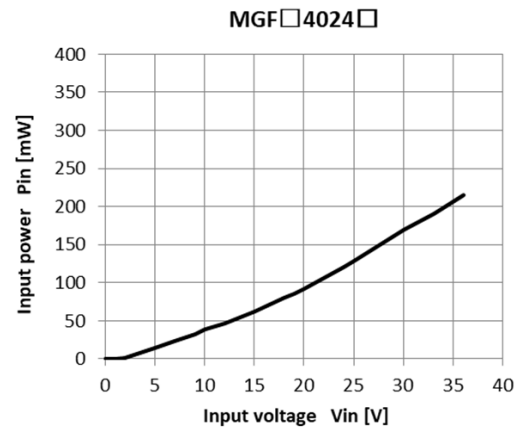
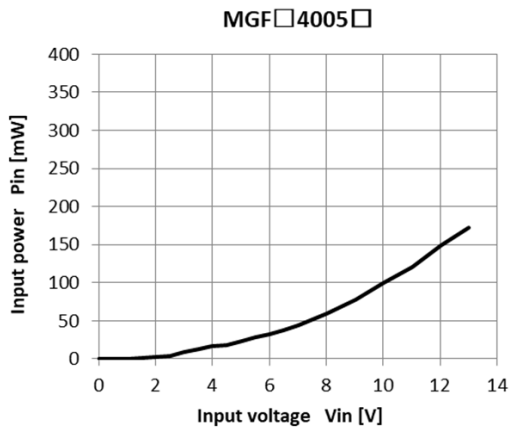
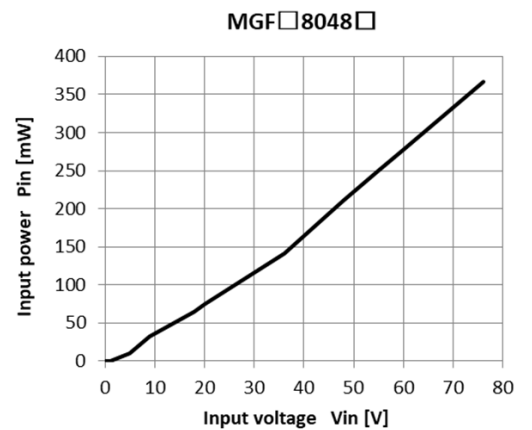
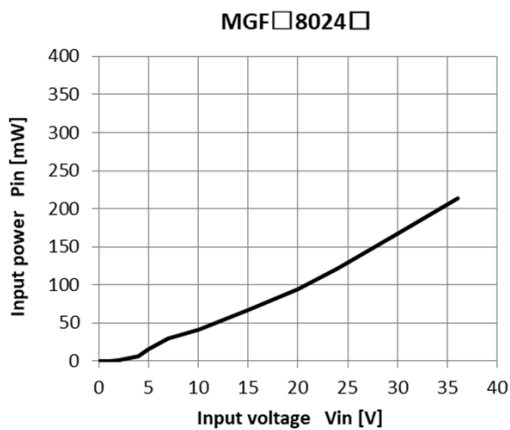

Fig.5.2.2
RC-OFF standby power
for MGFS80
/ MGFW80



5.3 RC pin outflow current

Fig.5.3.1
RC pin outflow
current
for MGF□4005□

MGF□4005□

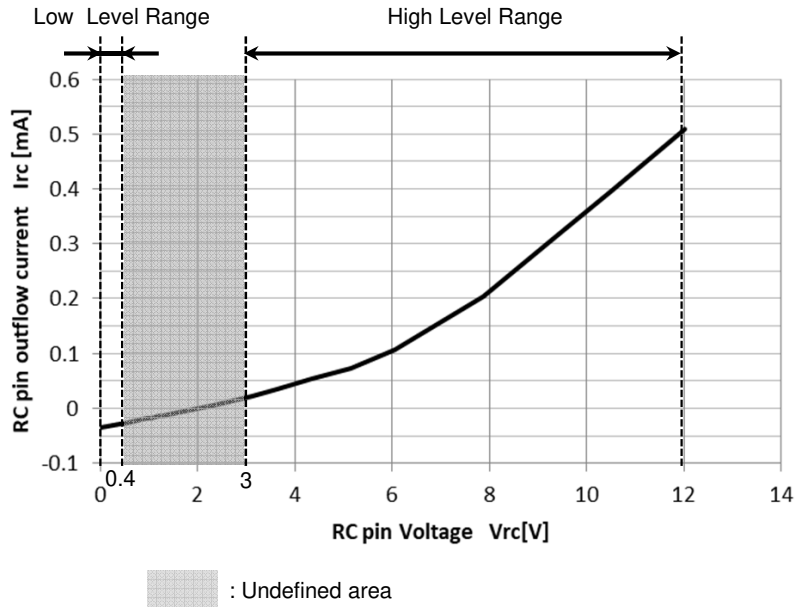
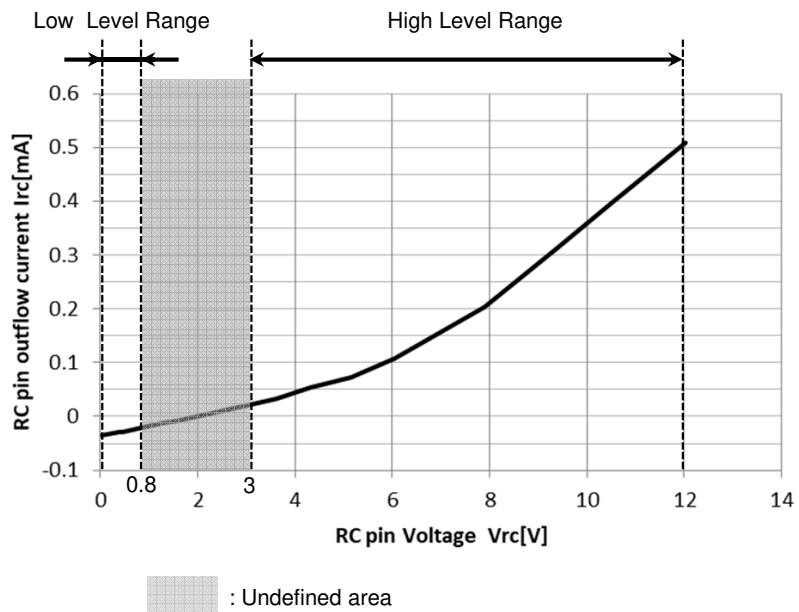

Fig.5.3.2
RC pin outflow
current
for MGF□4024□
/ MGF□4048□
/ MGF□8024□
/ MGF□8048□

MGF□4024□ / MGF□4048□
MGF□8024□ / MGF□8048□



6.Board layout

6.1 Measurement board layout

Fig.6.1.1
Recommended
circuit of connect
for MGFS40

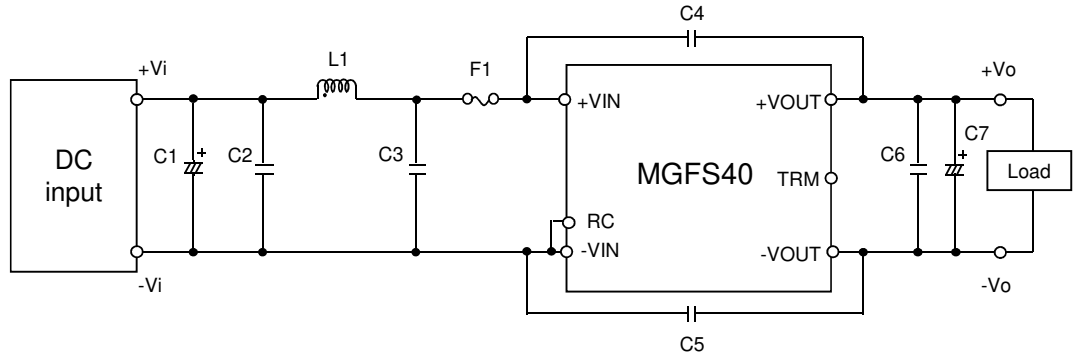
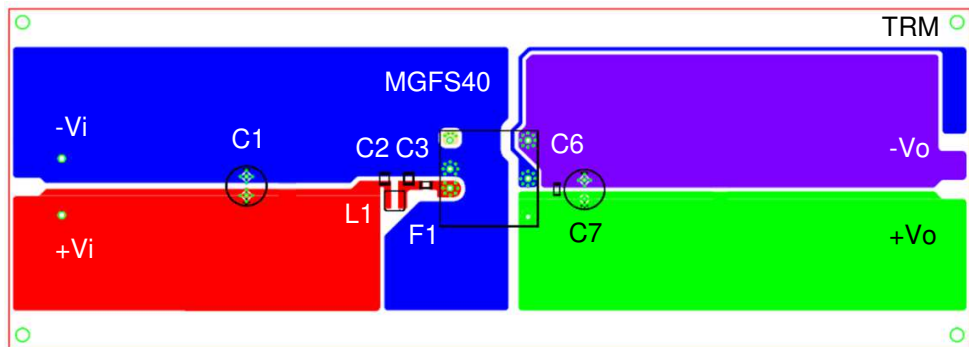
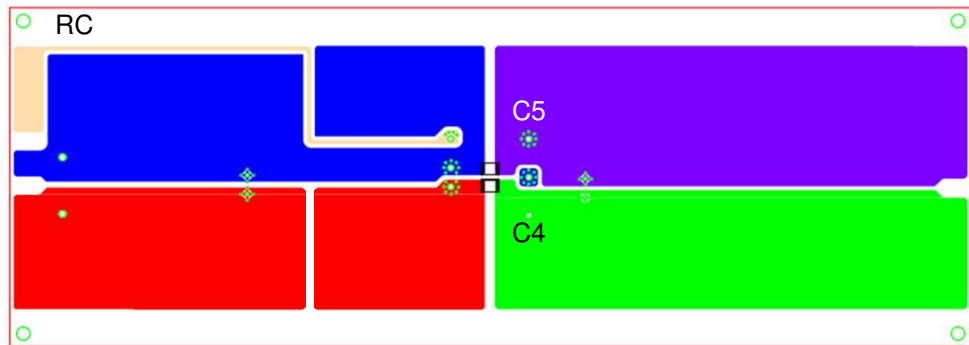

Fig.6.1.2
Measurement
board layout
for MGFS40



Front side



Back side

Please note that if foreign matter such as flux during soldering adheres to the vicinity of the case, the withstand voltage and isolation resistance may decrease.

Table 6.1.1
Parts name
for MGFS40

No.	Symbol	MGFS40		
		Division	Rating	Part name
1	F1	5Vinput	15A	KMS150
		24Vinput	10A	KMS100
		48Vinput	5A	KMS50
2	C1	5Vinput	35V 220 μ F	ELXZ350E□□221MH15D
		24Vinput	63V 100 μ F	ELXZ630E□□101MH15D
		48Vinput	100V 47 μ F	EKXG201E□□470MK20S
3	C2,C3	5Vinput	16V 22 μ F	GRM32ER71C226K
		24Vinput	50V 10 μ F	GRM32ER71H106K
		48Vinput	100V 4.7 μ F	HMK325AC7475K
4	L1	5Vinput	15.0A 1.0 μ H	SRP7050TA-1R0M
		24Vinput	12.0A 1.8 μ H	SRP7050TA-1R8M
		48Vinput	6.0A 5.6 μ H	SRP7050TA-5R6M
5	C4	5Vinput	2kV 1000pF	GR431BR7LA102K
		24Vinput		
		48Vinput		
6	C5	5Vinput	-	-
		24Vinput		
		48Vinput		
7	C6	ALL	25V 22 μ F	GRM32ER71E226K
		3.3Voutput	25V 470 μ F	PCR1E471MCL1GS
		5Voutput	25V 470 μ F	PCR1E471MCL1GS
		12Voutput	35V 150 μ F	PCR1V151MCL1GS
8	C7	15Voutput	63V 100 μ F	PCR1J101MCL1GS
		15Voutput	63V 100 μ F	PCR1J101MCL1GS

For MG40/MG80 series

Fig.6.1.3
Recommended
circuit of connect
for MGFW40

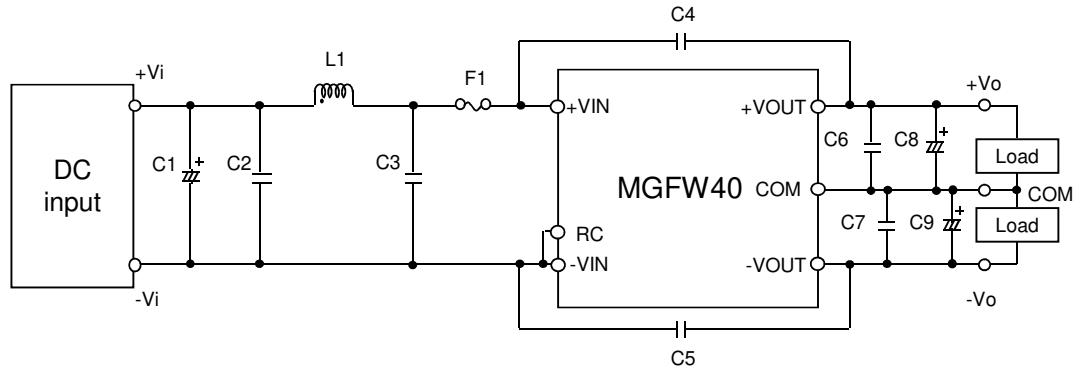
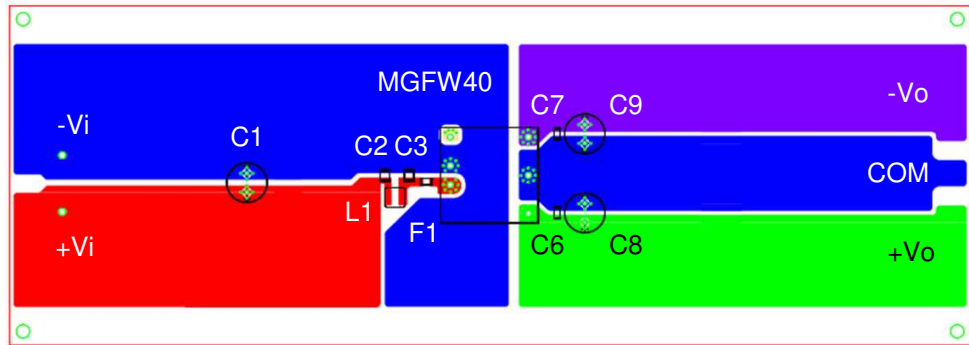
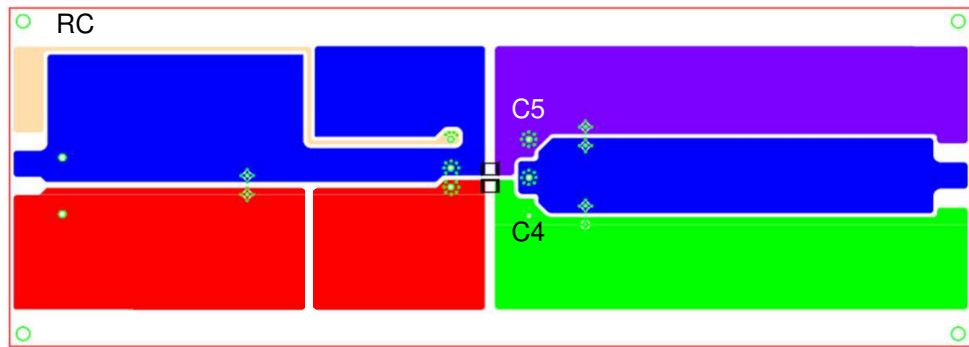

Fig.6.1.4
Measurement
board layout
for MGFW40



Front side



Back side

Please note that if foreign matter such as flux during soldering adheres to the vicinity of the case, the withstand voltage and isolation resistance may decrease.

Table 6.1.2
Parts name
for MGFW40

No.	Symbol	MGFW40		
		Division	Rating	Part name
1	F1	5Vinput	15A	KMS150
		24Vinput	10A	KMS100
		48Vinput	5A	KMS50
2	C1	5Vinput	35V 220 μ F	ELXZ350E□□221MH15D
		24Vinput	63V 100 μ F	ELXZ630E□□101MH15D
		48Vinput	100V 47 μ F	EKXG201E□□470MK20S
3	C2,C3	5Vinput	16V 22 μ F	GRM32ER71C226K
		24Vinput	50V 10 μ F	GRM32ER71H106K
		48Vinput	100V 4.7 μ F	HMK325AC7475K
4	L1	5Vinput	15.0A 1.0 μ H	SRP7050TA-1R0M
		24Vinput	12.0A 1.8 μ H	SRP7050TA-1R8M
		48Vinput	6.0A 5.6 μ H	SRP7050TA-5R6M
5	C4	5Vinput	2kV 1000pF	GR431BR7LA102K
		24Vinput		
		48Vinput		
6	C5	5Vinput	-	-
		24Vinput		
		48Vinput		
7	C6 , C7	ALL	25V 22 μ F	GRM32ER71E226K
8	C8 , C9	\pm 12Voutput	63V 100 μ F	PCR1J101MCL1GS
		\pm 15Voutput	80V 47 μ F	PCR1K470MCL1GS

For MG40/MG80 series

Fig.6.1.5
Recommended
circuit of connect
for MGFS80

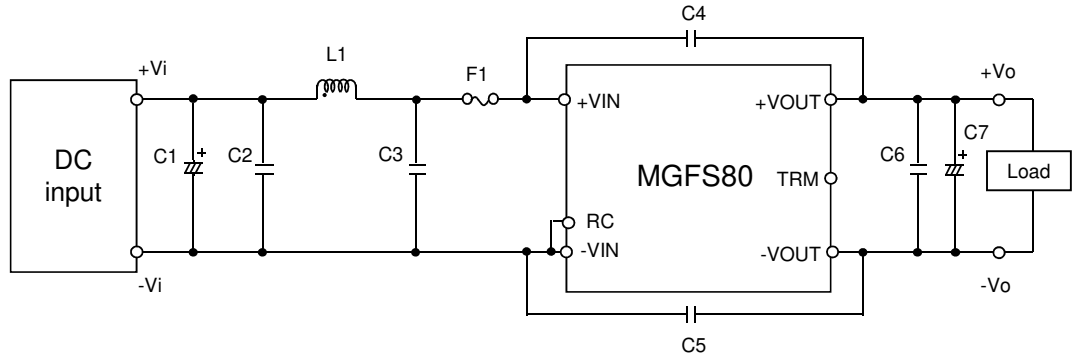
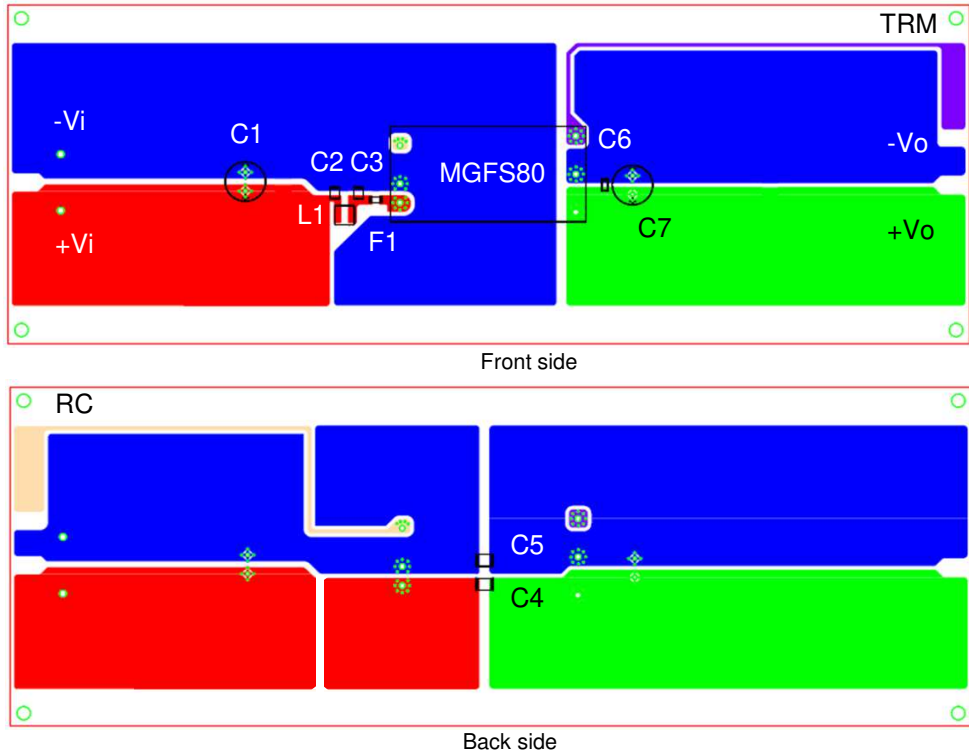

Fig.6.1.6
Measurement
board layout
for MGFS80



Please note that if foreign matter such as flux during soldering adheres to the vicinity of the case, the withstand voltage and isolation resistance may decrease.

Table 6.1.3
Parts name
for MGFS80

No.	Symbol	MGFS80		
		Division	Rating	Part name
1	F1	24Vinput	15A	KMS150
		48Vinput	10A	KMS100
2	C1	24Vinput	63V 100 μ F	ELXZ630E□□101MH15D
		48Vinput	100V 47 μ F	EKXG201E□□470MK20S
3	C2,C3	24Vinput	50V 10 μ F	GRM32ER71H106K
		48Vinput	100V 4.7 μ F	HMK325AC7475K
4	L1	24Vinput	12.0A 1.8 μ H	SRP7050TA-1R8M
		48Vinput	8.0A 3.3 μ H	SRP7050TA-3R3M
5	C4	24Vinput	2kV 2200pF	GR443QR73D222KW01
		48Vinput	2kV 3300pF	GR443QR73D332KW01
6	C5	24Vinput	2kV 2200pF	GR443QR73D222KW01
		48Vinput	2kV 3300pF	GR443QR73D332KW01
7	C6	ALL	25V 22 μ F	GRM32ER71E226K
		3.3Voutput	25V 470 μ F	PCR1E471MCL1GS
		5Voutput	25V 470 μ F	PCR1E471MCL1GS
		12Voutput	35V 150 μ F	PCR1V151MCL1GS
8	C7	15Voutput	63V 100 μ F	PCR1J101MCL1GS
		63V 100 μ F	PCR1J101MCL1GS	

For MG40/MG80 series

Fig.6.1.7
Recommended
circuit of connect
for MGFW80

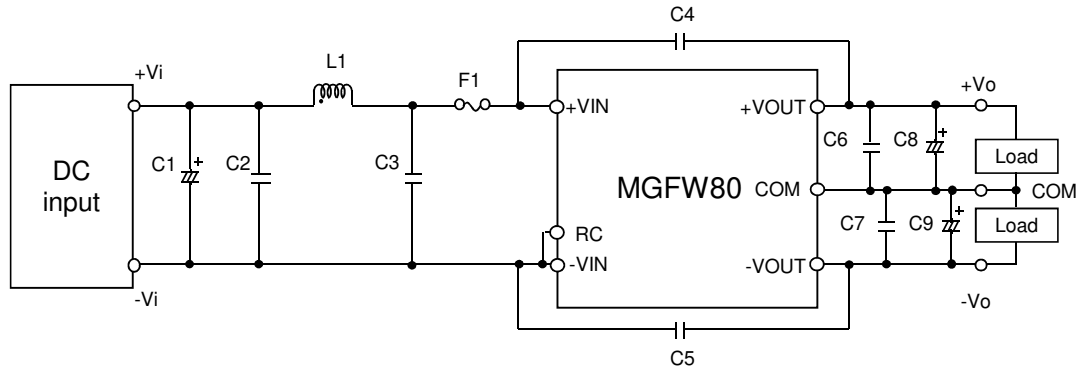
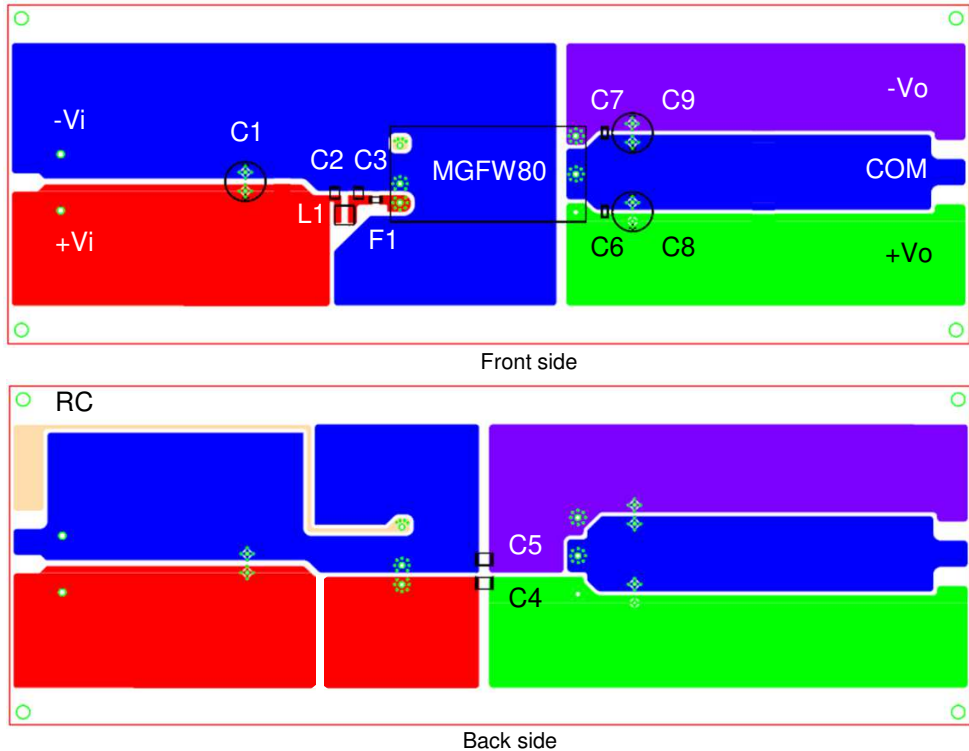

Fig.6.1.8
Measurement
board layout
for MGFW80



Please note that if foreign matter such as flux during soldering adheres to the vicinity of the case, the withstand voltage and isolation resistance may decrease.

Table 6.1.4
Parts name
for MGFW80

No.	Symbol	MGFW80		
		Division	Rating	Part name
1	F1	24Vinput	15A	KMS150
		48Vinput	10A	KMS100
2	C1	24Vinput	63V 100μF	ELXZ630E□□101MH15D
		48Vinput	100V 47μF	EKXG201E□□470MK20S
3	C2,C3	24Vinput	50V 10μF	GRM32ER71H106K
		48Vinput	100V 4.7μF	HMK325AC7475K
4	L1	24Vinput	12.0A 1.8μH	SRP7050TA-1R8M
		48Vinput	8.0A 3.3μH	SRP7050TA-3R3M
5	C4	24Vinput	2kV 2200pF	GR443QR73D222KW01
		48Vinput		
6	C5	24Vinput	2kV 2200pF	GR443QR73D222KW01
		48Vinput		
7	C6 , C7	ALL	25V 22μF	GRM32ER71E226K
8	C8 , C9	±12Voutput	63V 100μF	PCR1J101MCL1GS
		±15Voutput	80V 47μF	PCR1K470MCL1GS